

Cutting Material
TC

Number of Teeth
Z 2

Feed
MAN

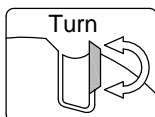

Design:

- Tool body in steel
- 5-piece cutter set, part screwed
- No. of Teeth = 2
- TC indexable cutter
- Drawing cut
- Bore up to maximum $\varnothing 40$ possible for an additional charge

Application:

- For the production of door frames (door lining) with 14mm seal or 12mm seal without cutter change in indexable cutter design

Workpiece Material:

- Solid wood and panel materials

Machine:

- Spindle moulders

Scope of Supply:

- Tool body incl. cutter
- 1 fixing ring 4mm
- 1 fixing ring 7.2mm
- 1 fixing ring 8mm
- 1 ring set 0.8mm
- 2 rings set 1mm
- 1 ring set 2mm
- 1 key with handle Torx T15
- 1 key with handle Torx T25
- 1 key with handle Torx T20
- 1 key with handle Allen key SW2.5
- 1 key with handle Allen key SW5
- 2 magnetic assembly jig

Special Features:

- Use of indexable TC cutters
- Suitable for various wood thicknesses

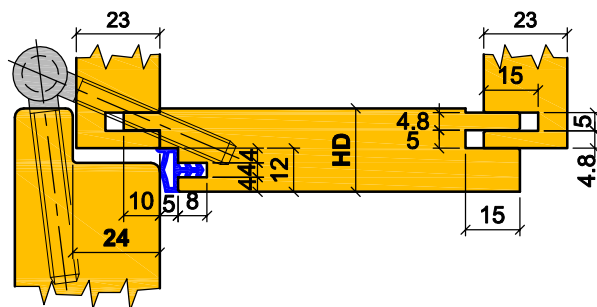
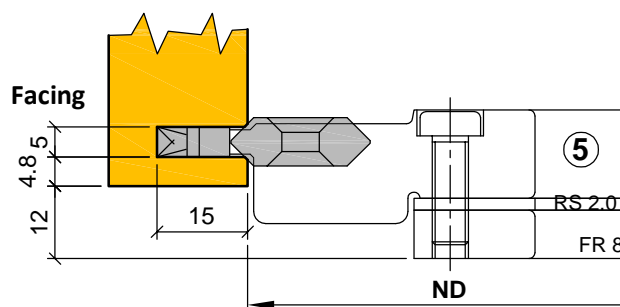
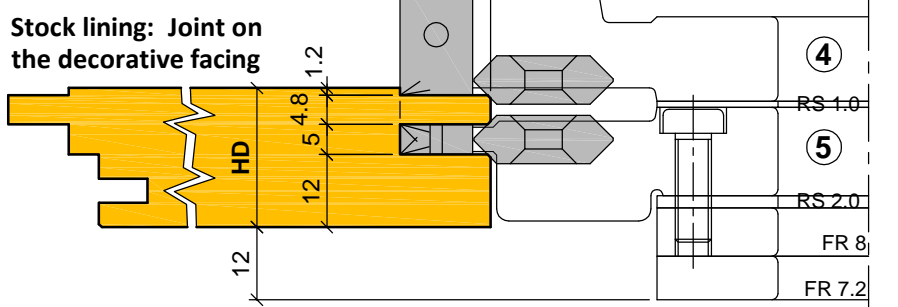
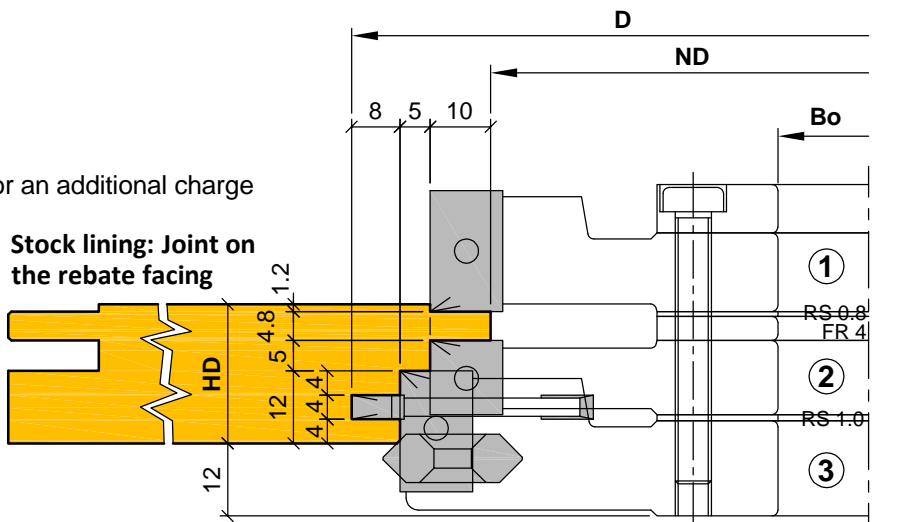

Aigner
WERKZEUGE

e-mail: office@aigner-werkzeuge.at
www.aigner-werkzeuge.at

Blattformat: **A4** All dimensions in mm

Zchnng.-Nr. KW.45510.4 00

C551

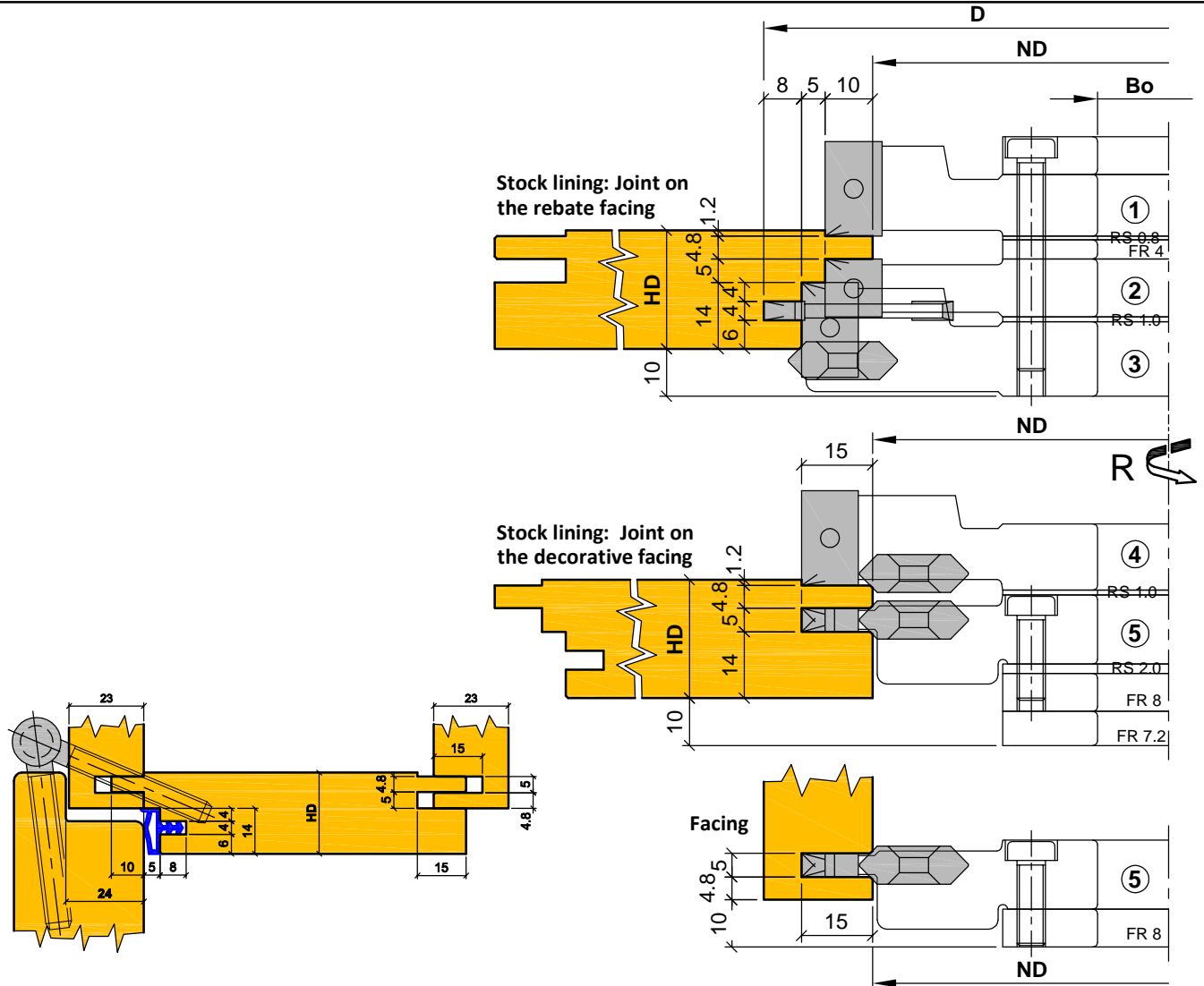

D	ND	HD	Bo	Z	FA	P	R/L	DZ	Ident-No.
171	125	22-41	30	2	1+2+3+4+5	14	R	4000-8000	C551-14
171	125	22-41	30	2	1+2+3+4+5	12	R	4000-8000	C551-12

Spare Parts				
Description	Qty.	Dimensions	MBM	Ident-No.
Indexable cutter for No. 1,3,4	2	20x12x1.5	10	WMF20x12/U
Indexable cutter for No. 2	2	12x12x1.5	10	WMF12x12/U
Indexable cutter for No. 5	2	4.6x12x2.5	10	WMF4.6x12x2.5/U
Spur for No. 1,2,3,4	8	14x14x2	10	VS14x14x2/U
Spur for No. 5	4	14x14x1.2	10	VS14x14x1.2/M
Grooving cutter SB4 for No. 3	2	40x25x4.0	2	KW.08061.5
Edge cutter chamfer for No. 3,4,5	2	23x15x8	2	KW.12465.5
Screw main cutter for No. 1,2,4	6	Grub screw T25 M8x16	10	KW.44253.5
Screw main cutter for No. 3	2	Grub screw T15 M6x16	10	KW.44252.5
Screw main cutter for No. 5	2	Eccentric B=3	2	KW.04766.4-3
Screw spur for No. 1,2,3,4	8	Countersunk screw M6x10	10	KW.33767.4-10
Nut spur for No. 5	4	Nut M4xD9.9xd8.45	10	KW.44245.5
Screw spur for No. 5	4	Screw TSP M4x4.2	10	KW.44244.5
Screw grooving cutter for No. 3	2	Grooving cutter screw M6x16	2	KW.04111.5
Screw edge cutter for Nos. 3,4,5	6	Countersunk screw M6x16	10	KW.33767.4-16

 <p>e-mail:office@aigner-werkzeuge.at www.aigner-werkzeuge.at</p>	Z.....No. of Teeth FA...Number of Cutters	Blattformat: A4	<small>All dimensions in mm</small> Zchnng.-Nr. KW.45510.4 00
	P.....Profile Variant	DZ.....Speed Range (rpm)	
	MBM.....Minimum Order Quantity		