

PM-Door-Rebate-Cutter-Set

C525

Cutting Material
TC

Number of Teeth
Z 2

Feed
MAN

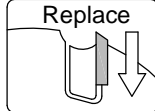

Design:

- 3-piece set pinned
- Tool body in steel
- No. of Teeth = 2
- TC profile cutters
- Drawing cut
- Bore up to maximum Ø40 possible for an additional charge

Application:

- For door surround milling on stationary machines in soft or hard woods and various bonded materials

Workpiece Material:

- Solid wood and panel materials

Machine:

- Spindle moulders

Scope of Supply:

- 3-piece set incl. profile cutters
- With cutter No. 1 PM.20090.5/U35 R2.5 pre-assembled
- With cutter No. 3 PM.20095.5/U35 R2.5 pre-assembled
- If another cutter is to be fitted it must be stated at the time
- The possible profile cutters can be seen on the following page
- 1 key with handle Torx T40
- 1 key with handle Allen key SW5
- 1 ring set 18mm
- (Optional 2 sealing groove cutters for No.2)
- (Optional 1 key with handle Torx T25)

Special Features:

- Rebate edge optionally rounded or chamfered.
- 5 overlap profiles in 1 tool body

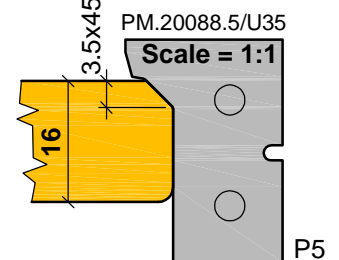
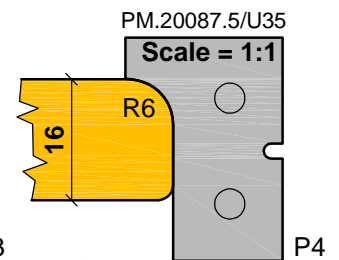
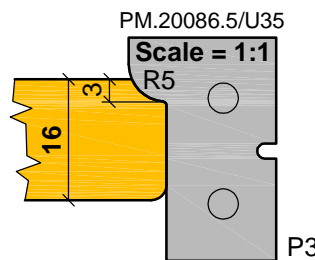
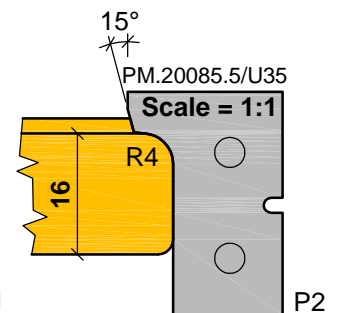
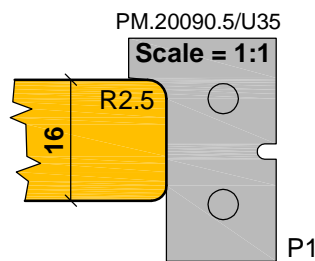
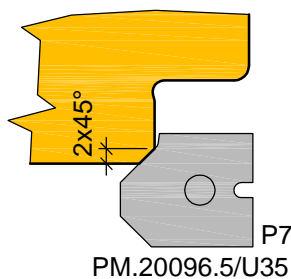
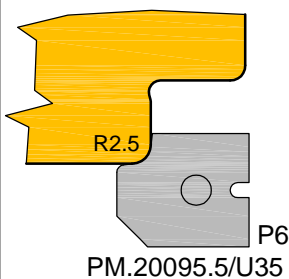
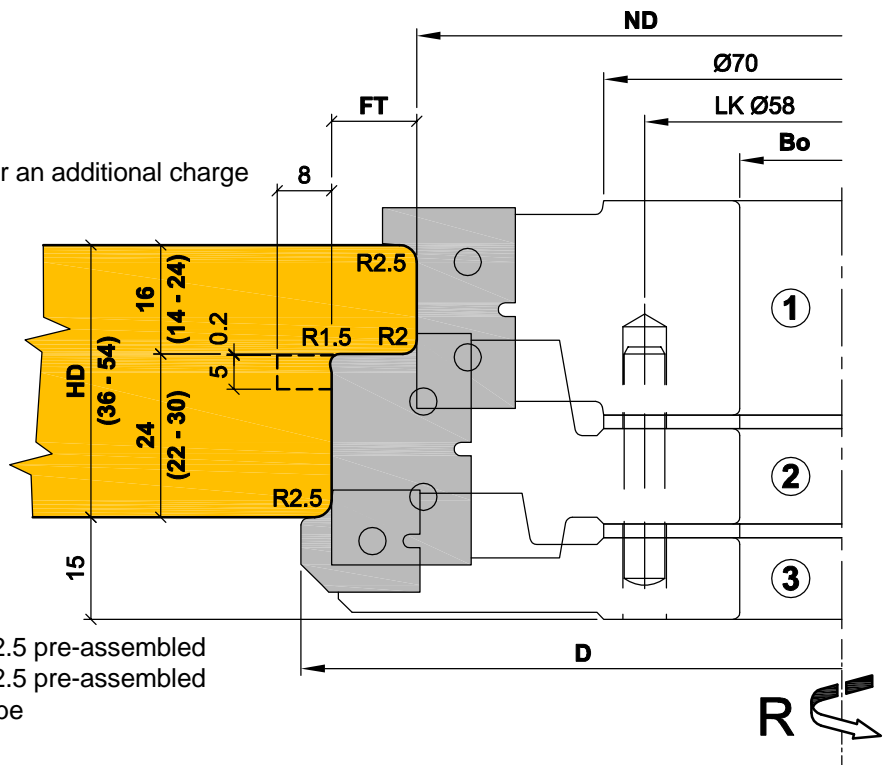

Aigner
WERKZEUGE

e-mail: office@aigner-werkzeuge.at
www.aigner-werkzeuge.at

Blattformat: **A4** All dimensions in mm

Zchnng.-Nr. KW.45250.4 | 00

C525

D	ND	HD	FT	Bo	Z	P	R/L	DZ	Ident-No.
159	125	36-54	12.5	30	2	R2.5	R	4500-7500	C525-125
162	125	36-54	14	30	2	R2.5	R	4500-7500	C525-14
164	125	36-54	15	30	2	R2.5	R	4500-7500	C525-15
166	125	36-54	16	30	2	R2.5	R	4500-7500	C525-16

Spare Parts				
Description	Qty.	Dimensions	MBM	Ident-No.
Profile cutter P1 for No. 1 R2.5	2	30x18.2x2	2	PM.20090.5/U35
Profilmesser P2 für Nr.1 R4 (Option)	2	30x19x2	2	PM.20085.5/U35
Profile cutter P3 for No. 1 R5 (Option)	2	30x18.1x2	2	PM.20086.5/U35
Profile cutter P4 for No. 1 R6 (option)	2	30x19.6x2	2	PM.20087.5/U35
Profile cutter P5 for No.1 cham. (option)	2	30x19.3x2	2	PM.20088.5/U35
Profile cutter for No. 2 "FT 12.5"	2	35x20.7x2	2	PM.20094.5/U35
Profile cutter for No. 2 "FT 14"	2	35x22.3x2	2	PM.20093.5/U35
Profile cutter for No. 2 "FT 15"	2	35x23.4x2	2	PM.20092.5/U35
Profile cutter for No. 2 "FT 16"	2	35x24.4x2	2	PM.20091.5/U35
Profile cutter P6 for No. 3	2	15x17.8x2	2	PM.20095.5/U35
Profile cutter P7 for No. 3	2	15x17.8x2	2	PM.20096.5/U35
Grooving cutter SB5 (option)	2	40x25x5.0	2	KW.08057.5
Screw grooving cutter	2	Grooving cutter screw M6x16	2	KW.04111.5

 <p>e-mail:office@aigner-werkzeuge.at www.aigner-werkzeuge.at</p>	Z.....No. of Teeth	Blattformat: A4 <small>All dimensions in mm</small>
	P.....Profile Variant	
DZ.....Speed Range (rpm)	C525-1	
MBM.....Minimum Order Quantity		