

WM-Chamfer-Cutter 45°

C455

Cutting Material
TC

Feed
MAN

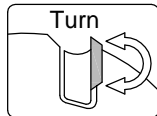

Design:

- Tool body in steel
- TC reversible cutter
- Bore up to max. Ø40 possible at extra cost

Application:

- Chamfer cutting

Workpiece material:

- Solid wood and panel materials

Machine:

- Spindle moulders

Scope of supply:

- Tool body including reversible cutter pre-assembled
- Associated key with handle

Special features:

- Same zero diameter and run-off edge for all widths of cut (see C455-2, C455-3)

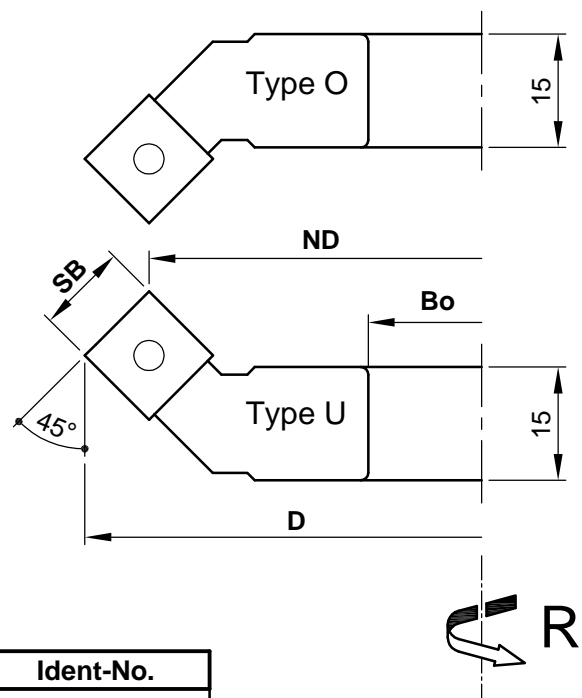

D	ND	SB	Bo	Z	Typ	R/L	DZ	Ident-No.
105	88	12	30	2	O	R	7300-12700	C455-12088-O
105	88	12	30	2	U	R	7300-12700	C455-12088-U
115	98	12	30	2	O	R	6600-11600	C455-12098-O
115	98	12	30	2	U	R	6600-11600	C455-12098-U
140	123	12	30	2	O	R	5500-9600	C455-12123-O
140	123	12	30	2	U	R	5500-9600	C455-12123-U
155	138	12	30	2	O	R	5000-8600	C455-12138-O
155	138	12	30	2	U	R	5000-8600	C455-12138-U
165	148	12	30	2	O	R	4600-8000	C455-12148-O
165	148	12	30	2	U	R	4600-8000	C455-12148-U
180	163	12	30	2	O	R	4200-7500	C455-12163-O
180	163	12	30	2	U	R	4200-7500	C455-12163-U

Spare Parts				
Description	Qty	Dimensions	MBM	Ident-No.
Reversible Cutter for SB12	2	WMF12x12x1.5	10	WMF12x12/U
Screw Main Cutter	2	Grub Screw T15 M6x16	10	KW.44252.5

<p>e-mail: office@aigner-werkzeuge.at www.aigner-werkzeuge.at</p>	Z.....No. of teeth	Blattformat: A4 <small>All dimensions in mm</small>
	L.....Position: O.....Top U.....Bottom	
DZ.....Speed Range (rpm)	C455-1	
MBM.....Minimum Order Quantity		

WM-Chamfer-Cutter 45°

C455

Cutting Material
TC

Feed
MAN

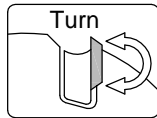

Design:

- Tool body in steel
- TC reversible cutter
- Bore up to max. Ø40 possible at extra cost

Application:

- Chamfer cutting

Workpiece material:

- Solid wood and panel materials

Machine:

- Spindle moulders

Scope of supply:

- Tool body including reversible cutter pre-assembled
- Associated key with handle

Special features:

- Same zero diameter and run-off edge for all widths of cut (see C455-1, C455-3)

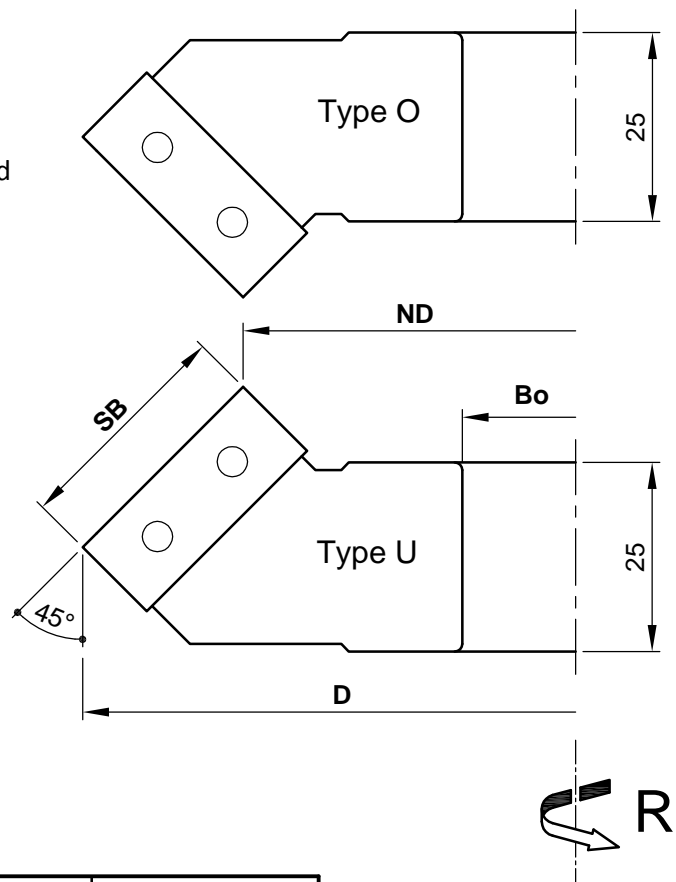

D	ND	SB	Bo	Z	Typ	R/L	DZ	Ident-No.
130.4	88	30	30	2	O	R	5800-10300	C455-30088-O
130.4	88	30	30	2	U	R	5800-10300	C455-30088-U
140.4	98	30	30	2	O	R	5500-9500	C455-30098-O
140.4	98	30	30	2	U	R	5500-9500	C455-30098-U
165.4	123	30	30	2	O	R	4600-8000	C455-30123-O
165.4	123	30	30	2	U	R	4600-8000	C455-30123-U
180.4	138	30	30	2	O	R	4200-7500	C455-30138-O
180.4	138	30	30	2	U	R	4200-7500	C455-30138-U

Spare Parts

Description	Qty.	Dimensions	MBM	Ident-No.
Reversible Cutter for SB30	2	WMF30x12x1.5	10	WMF30x12/U
Screw Main Cutter	4	Grub Screw T25 M8x16	10	KW.44253.5

Aigner
WERKZEUGE
e-mail: office@aigner-werkzeuge.at
www.aigner-werkzeuge.at

Z.....No. of teeth
L.....Position: O.....Top I U.....Bottom
DZ.....Speed Range (rpm)
MBM.....Minimum Order Quantity

Blattformat: **A4** All dimensions in mm
Zchnng.-Nr. KW.44550.4 | 00
C455-2

WM-Chamfer-Cutter 45°

C455

Cutting Material
TC

Feed
MAN

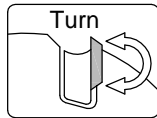

Design:

- Tool body in steel
- TC reversible cutter
- Bore up to max. Ø40 possible at extra cost

Application:

- Chamfer cutting

Workpiece material:

- Solid wood and panel materials

Machine:

- Spindle moulders

Scope of supply:

- Tool body including reversible cutter pre-assembled
- Associated key with handle

Special features:

- Same zero diameter and run-off edge for all widths of cut (see C455-1, C455-2)

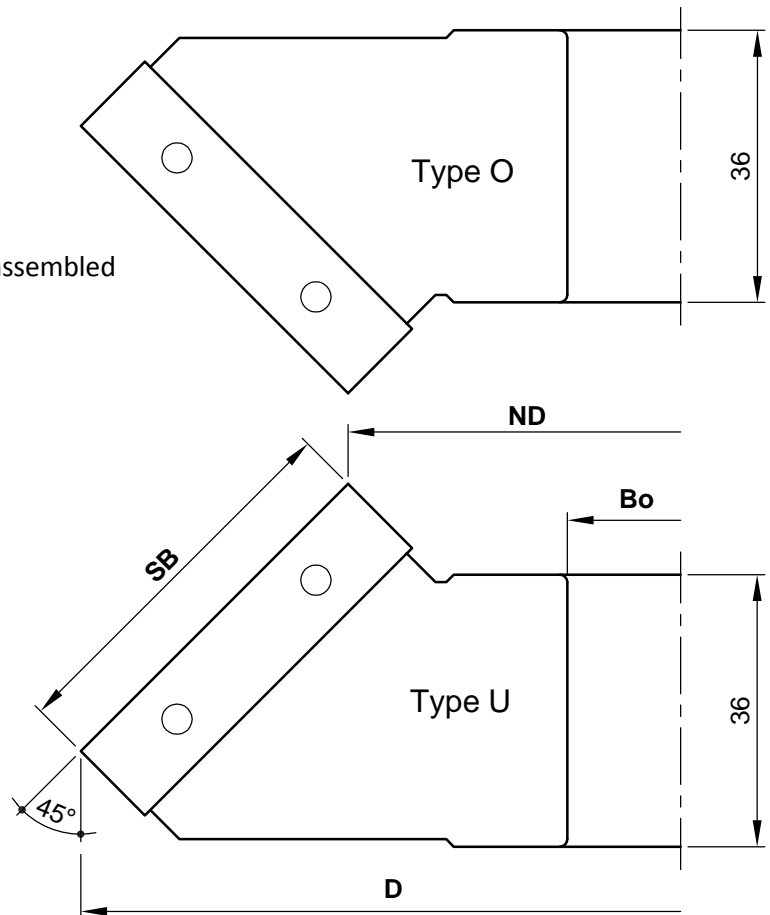

D	ND	SB	Bo	Z	Typ	R/L	DZ	Ident-No.
158.7	88	50	30	2	O	R	5000-8500	C455-50088-O
158.7	88	50	30	2	U	R	5000-8500	C455-50088-U
168.7	98	50	30	2	O	R	4500-8000	C455-50098-O
168.7	98	50	30	2	U	R	4500-8000	C455-50098-U
193.7	123	50	30	2	O	R	4000-6500	C455-50123-O
193.7	123	50	30	2	U	R	4000-6500	C455-50123-U
208.7	138	50	30	2	O	R	4000-6500	C455-50138-O
208.7	138	50	30	2	U	R	4000-6500	C455-50138-U



Spare Parts				
Description	Qty.	Dimensions	MBM	Ident-No.
Reversible Cutter for SB50	2	WMF50x12x1.5	10	WMF50x12/U
Screw Main Cutter	4	Grub Screw T25 M8x16	10	KW.44253.5

 <p>e-mail: office@aigner-werkzeuge.at www.aigner-werkzeuge.at</p>	Z.....No. of teeth	Blattformat: A4 <small>All dimensions in mm</small>
	L.....Position: O.....Top I U.....Bottom	Zchnng.-Nr. KW.44550.4 00
DZ.....Speed Range (rpm)	C455-3	
MBM.....Minimum Order Quantity		