

WM-Door-Rebating-Cutter

C380

Cutting Material
TC

Number of Teeth
Z 2

Feed
MEC

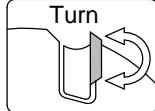

Design:

- Tool body in light alloy

Application:

- Rebating of interior doors

Workpiece material:

- Solid wood and panel materials

Machine:

- CNC machining centres

Scope of supply:

- 2-piece tool set including cutters and rings
- Associated key with handle
- Also optionally assembled (and balanced) (MS):
Mounted on milling arbor HSK-F 63 (C905-8030xx): C380-....-F2
- (Option) 2 solid TC sealing groove cutters of choice for rebate cutters
- (Option) 3 various rollover profiles of choice

Special features:

- Suitable for HPL covered door rebates thanks to standard TC cutters and the use of edge elements

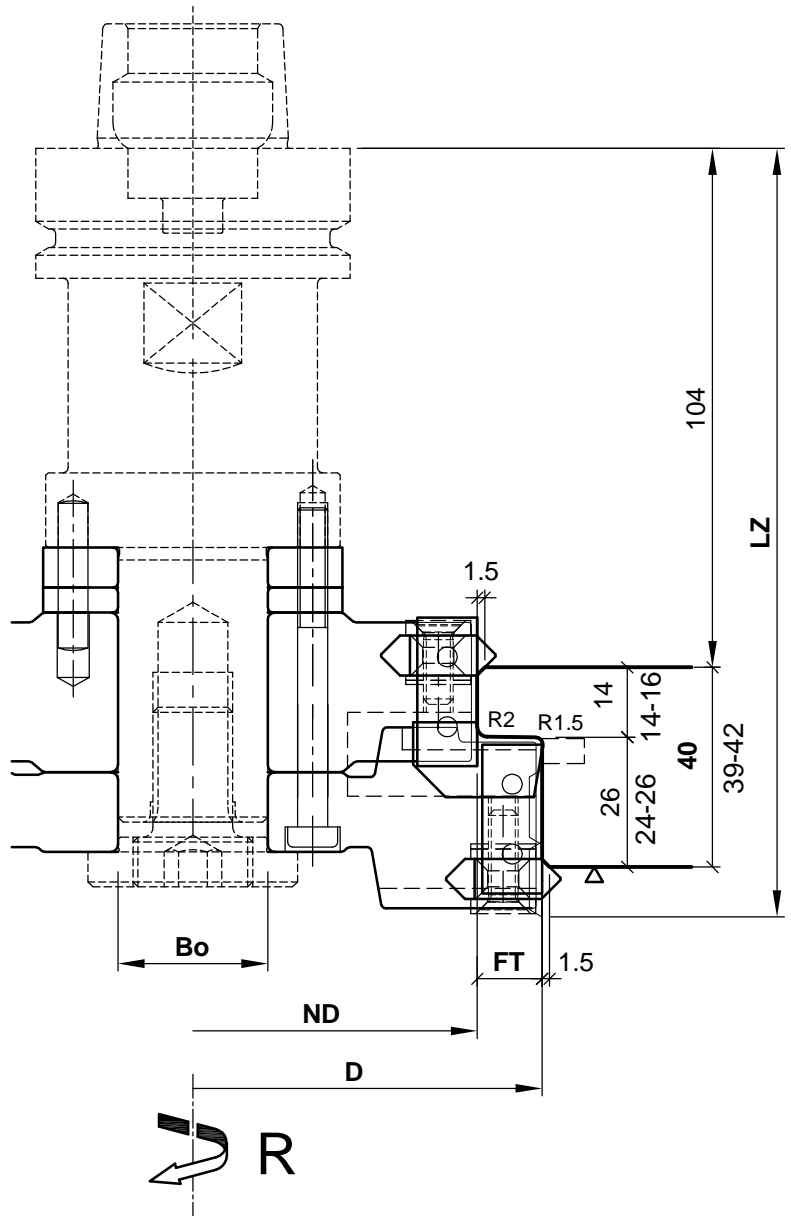

Optionally Available

Groove cutter solid carbide SB4.0

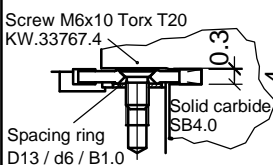

Groove cutter solid carbide SB5.0

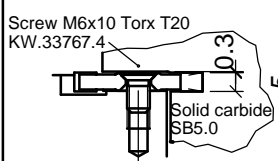

Also available in 3 different rollover profiles and in rebate edge R2 in accordance with Drg. No. C380-00-V1

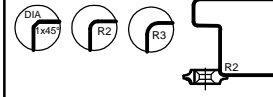

Aigner
WERKZEUGE

e-mail: office@aigner-werkzeuge.at
www.aigner-werkzeuge.at

MS.....Machine Adaptor

Blattformat: **A4** All dimensions in mm

Zchnng.-Nr. KW.43800.4 | 00

C380

D	ND	FT	Bo	LZ	Z	R/L	n max.	Ident-No.
140	114	13	30		2	R	9800	C380-13
140	114	13	30	154	2	R	9800	C380-13-F2
140	112	14	30		2	R	9800	C380-14
140	112	14	30	154	2	R	9800	C380-14-F2
140	110	15	30		2	R	9800	C380-15
140	110	15	30	154	2	R	9800	C380-15-F2
140	108	16	30		2	R	9800	C380-16
140	108	16	30	154	2	R	9800	C380-16-F2

Spare Parts				
Description	Qty.	Dimensions	MBM	Ident.No.
Reversible Cutter	4	30x12x1.5	10	WMF30x12/U
Spur for 380-13	2	26x15x2.0	2	PM.42006.5
Spur for 380-14	2	26x15x2.0	2	PM.45400.5
Spur for 380-15	2	26x15x2.0	2	PM.44596.5
Spur for 380-16	2	26x15x2.0	2	PM.44687.5
Circumference Cutter	4	15x15x2.5	10	KW.18065.5
Edge Cutter Bevel	4	23x15x8	2	KW.12465.5
Grooving Cutter SB5.0 (option)	2	34x16x5.0	2	VHMSB5.0
Grooving Cutter SB4.0 (option)	2	34x16x4.0	2	VHMSB4.0
Screw Reversible Cutter	4	Socket Head Screw T40 M8x21	10	KW.09697.5
Screw Reversible Cutter	4	Allen Screw M4x6	10	KW.44249.5
Screw Spur	4	Roundhead Screw T15 M4x8	10	KW.44236.5
Screw Circumference Cutter	4	Countersunk Screw T20 M6x10	10	KW.33767.4-10
Screw Edge Cutter	4	Countersunk Screw T20 M6x20	10	KW.33767.4-20
Screw Grooving Cutter	2	Countersunk Screw T20 M6x10	10	KW.33767.4-10

 e-mail:office@aigner-werkzeuge.at www.aigner-werkzeuge.at	Z.....No. of teeth	Blattformat: A4	All dimensions in mm
	n max.....Maximum Rotational Speed (rpm)	Zchnng.-Nr. KW.43800.4	
	MBM.....Minimum Order Quantity	C380-1	

Optionally Available

Rollover profile edge cutter bevel Dia
Rebate edge cutter bevel DIA

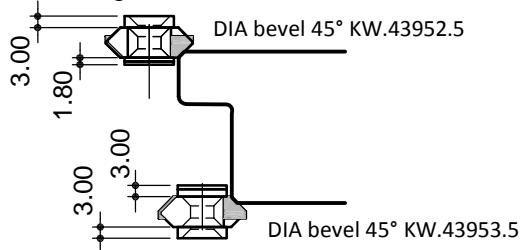

Spare Parts

Description	Qty.	Dimensions	MBM	Ident-No.
Reversible Cutter	4	30x12x1.5	10	WMF30x12/U
Circumference Cutter	2	15x15x2.5	10	KW.18065.5
Edge Cutter Bevel DIA top (option)	2	23x15x8	2	KW.43952.5
Edge Cutter Bevel DIA bottom (option)	2	23x15x8	2	KW.43953.5

Optionally Available

Rollover profile radius 2 rebate edge radius 2

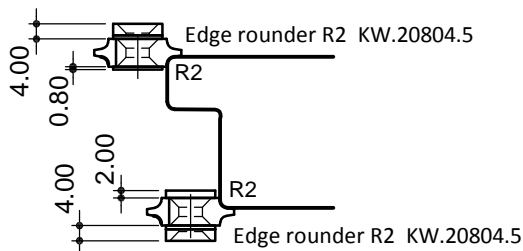

Spare Parts

Description	Qty	Dimensions	MBM	Ident-No.
Reversible Cutter	4	30x12x1.5	10	WMF30x12/U
Circumference Cutter	2	15x15x2.5	10	KW.18065.5
Edge Rounder Top R2	2	23x15x8	2	KW.20804.5
Edge Rounder Bottom R2	2	23x15x8	2	KW.20804.5

Optionally Available

Rollover profile radius 3 rebate edge radius 2

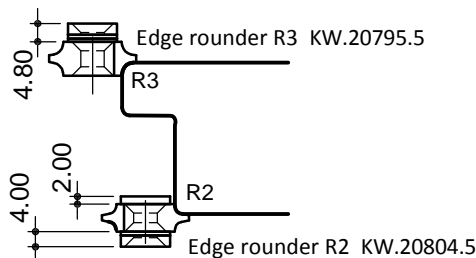

Spare Parts

Description	Qty.	Dimensions	MBM	Ident-No.
Reversible Cutter	4	30x12x1.5	10	WMF30x12/U
Circumference Cutter	2	15x15x2.5	10	KW.18065.5
Edge Rounder Top R3	2	23x15x8	2	KW.20795.5
Edge Rounder Bottom R2	2	23x15x8	2	KW.20804.5

Aigner
WERKZEUGE
e-mail:office@aigner-werkzeuge.at
www.aigner-werkzeuge.at

MBM.....Minimum Order Quantity

Blattformat: **A4** All dimensions in mm

Zchnng.-Nr. KW.43800.4 | 00

C380-00-V1