

IV 68 Vertikalschnitt

Regenschiene 25mm

1 Falzdichtung / 1 Überschlagdichtung

Gleiche Schlitz - Zapfenteilung

bei Flügel und Stock (2-fach)

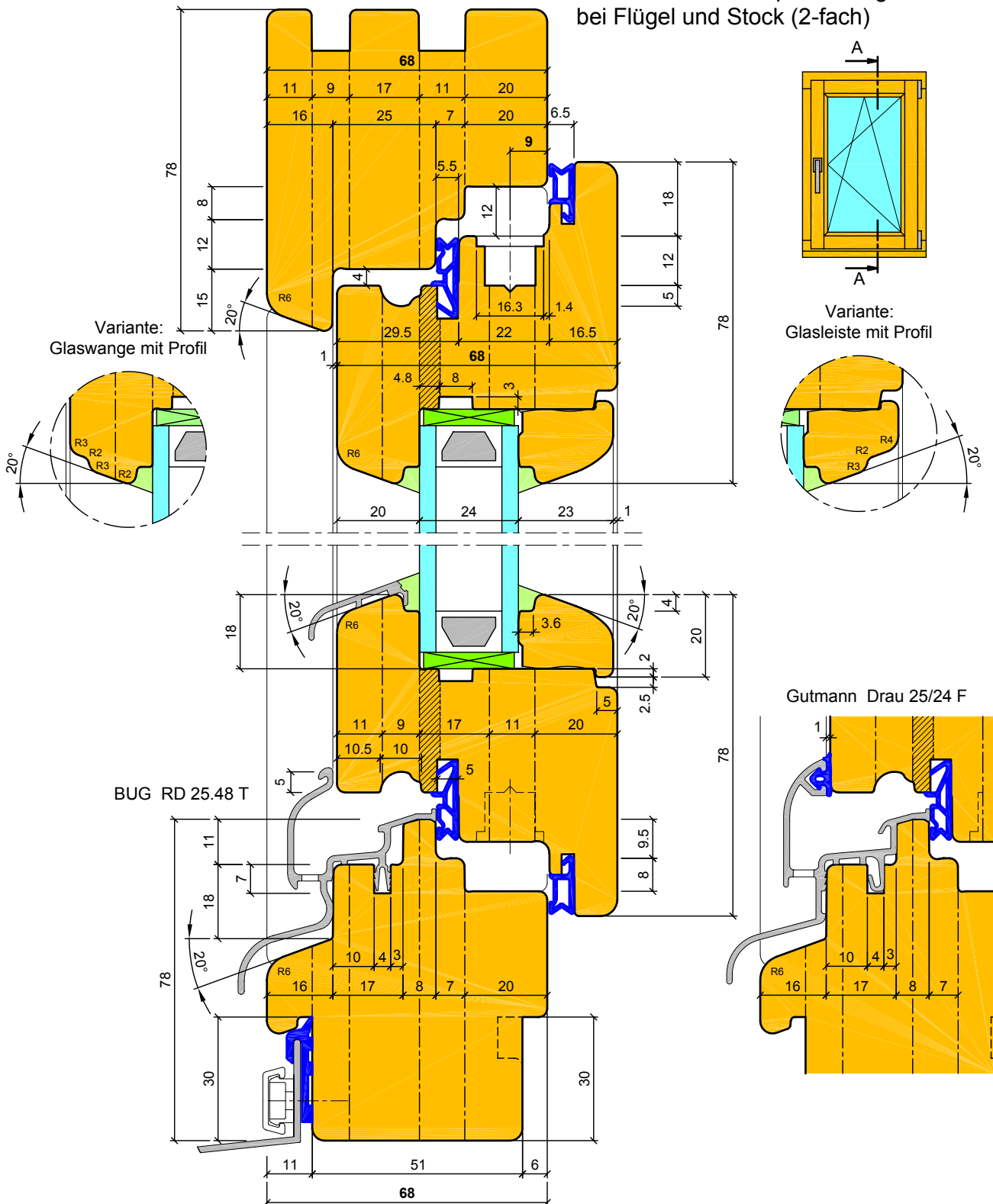

**IV 68 Horizontalschnitt Mittelschluß (Stulp)
ohne Schlagleiste**

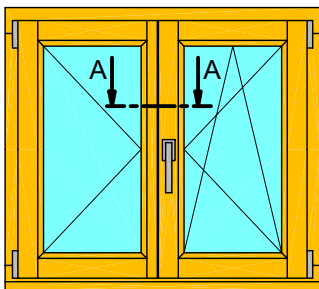
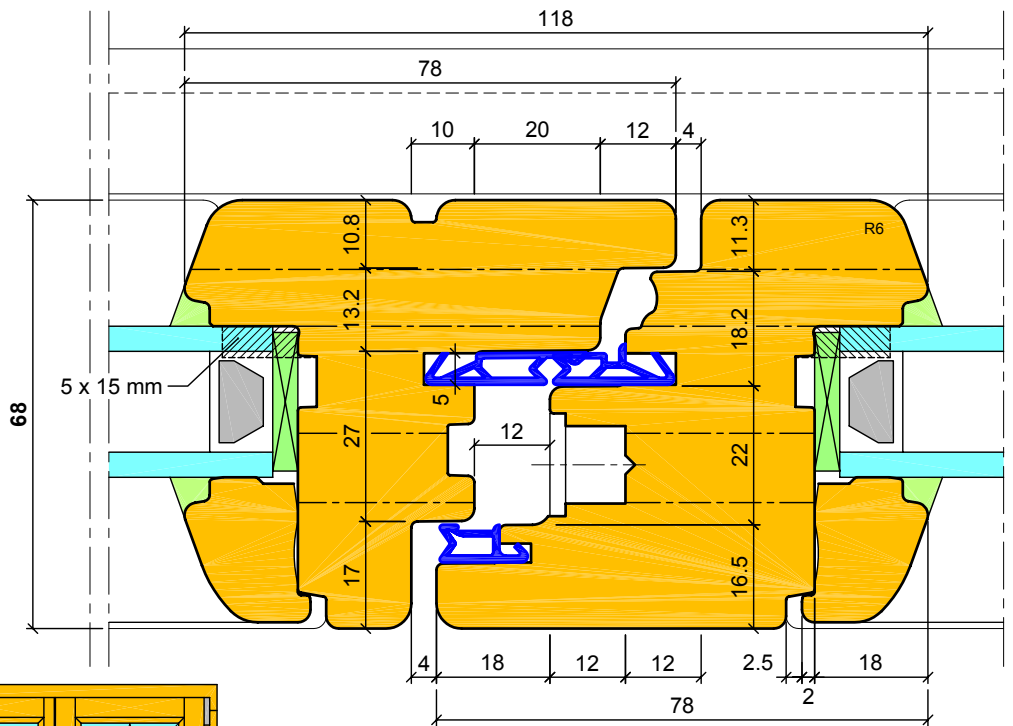

**Mittelschluß (Stulp)
mit Schlagleiste**

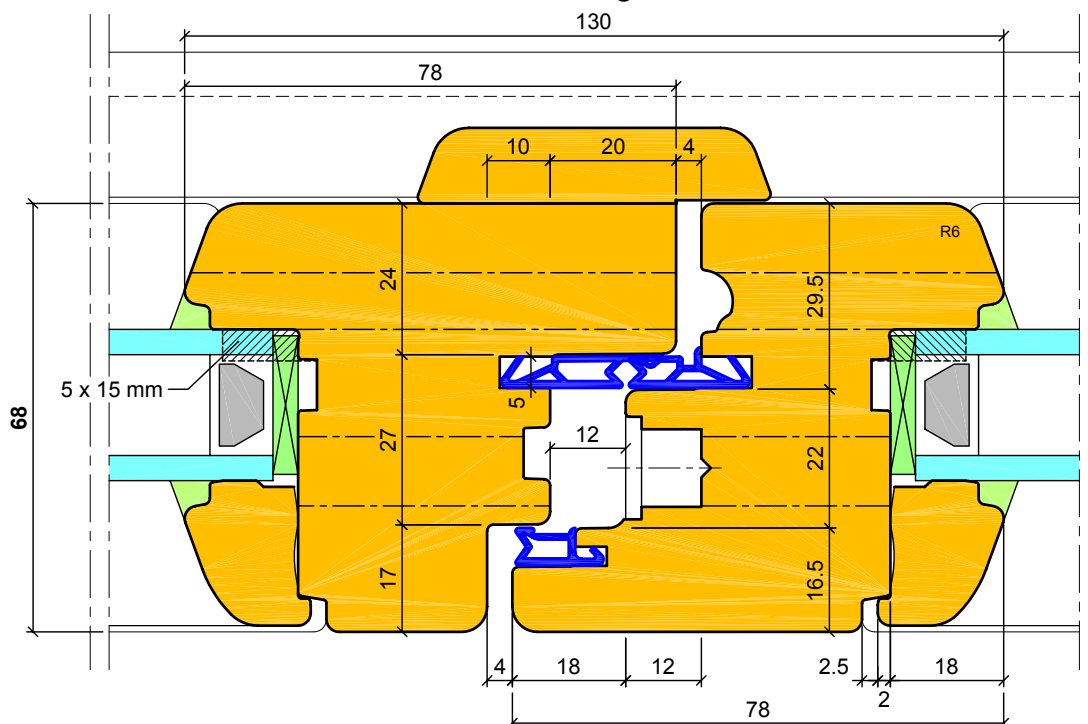

**IV 68 Vertikalschnitt
Aufdoppelung**

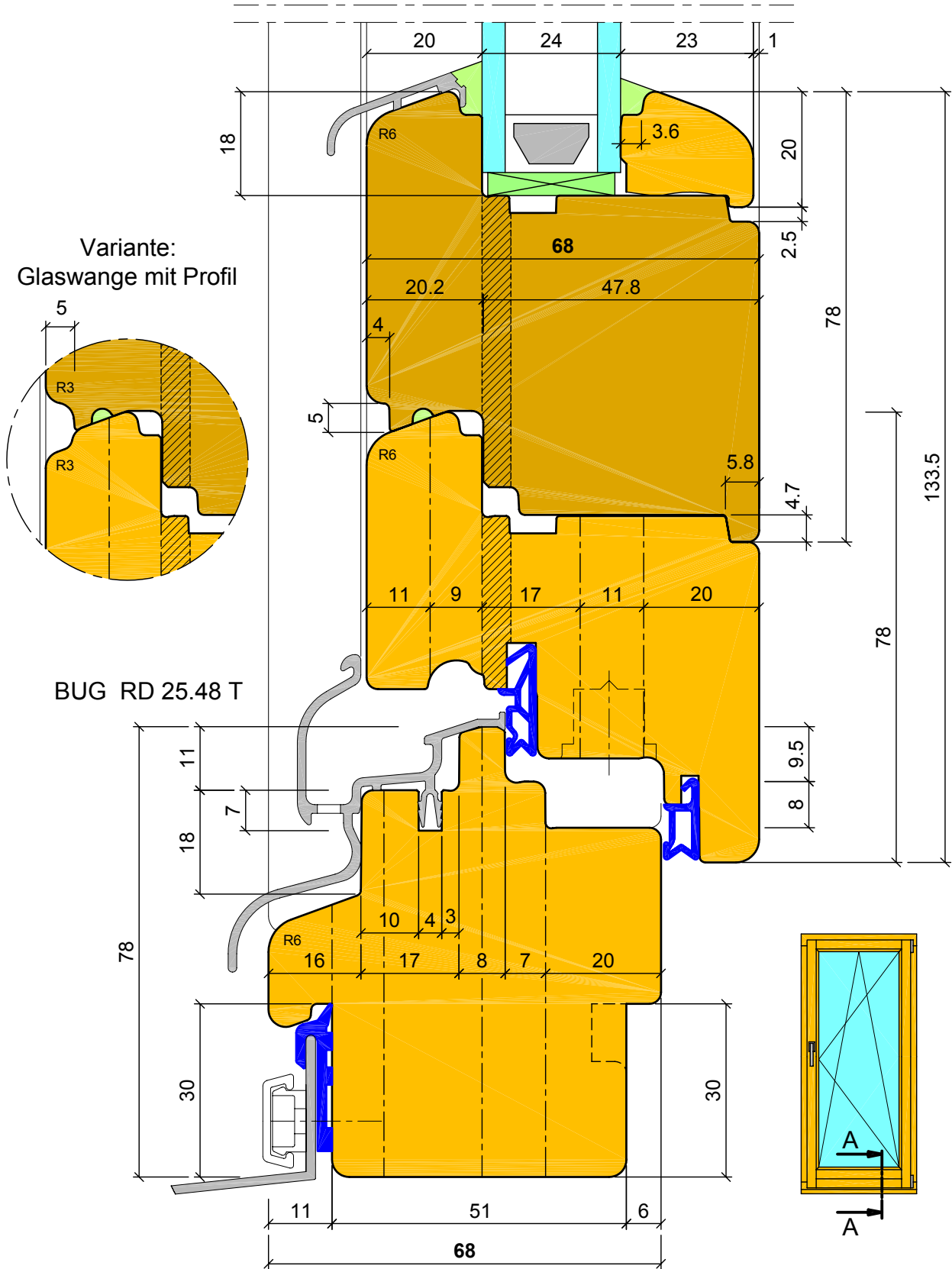

IV 68 Vertikalschnitt
Klebesprossen

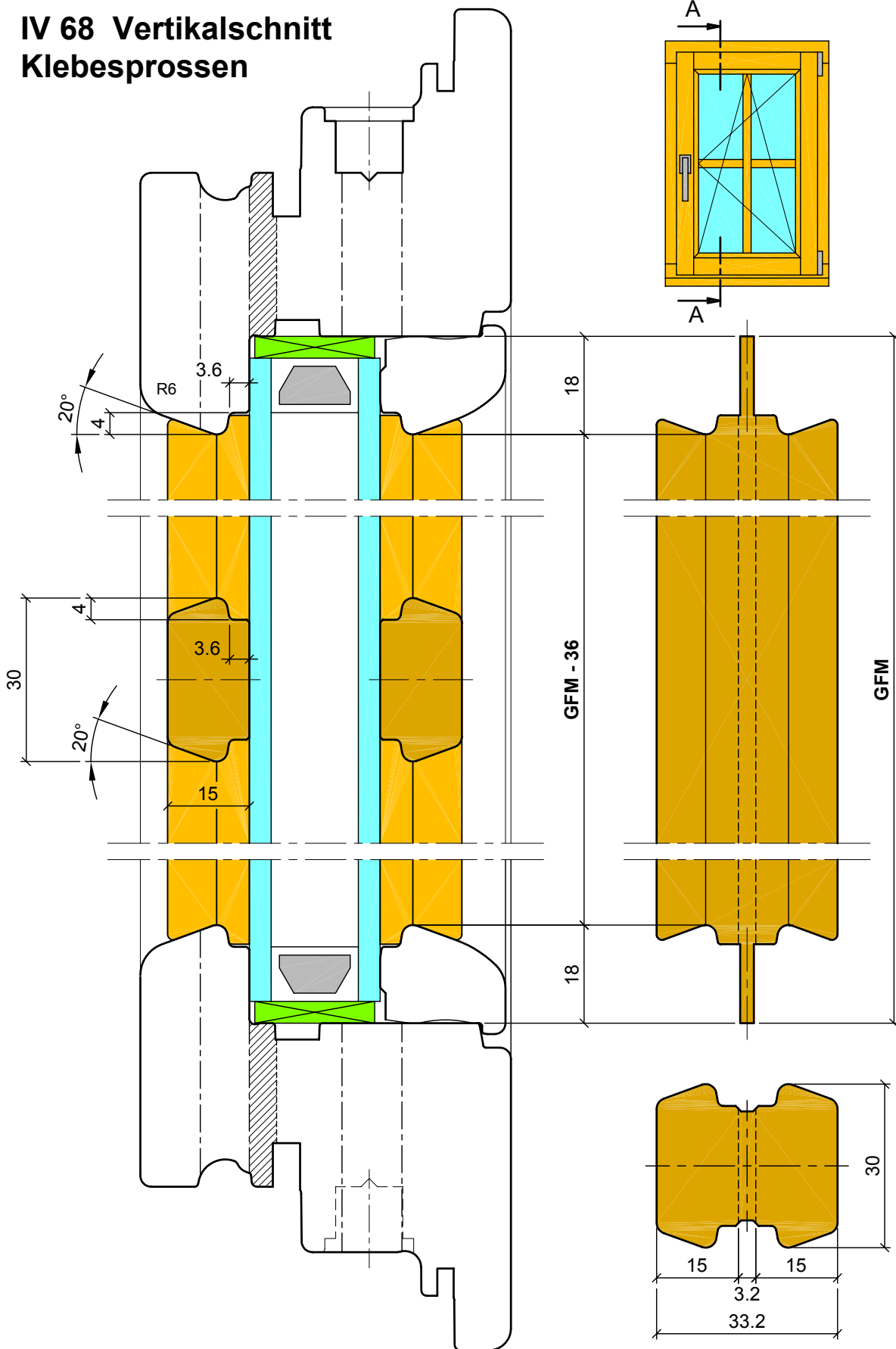

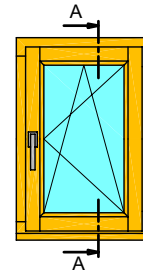
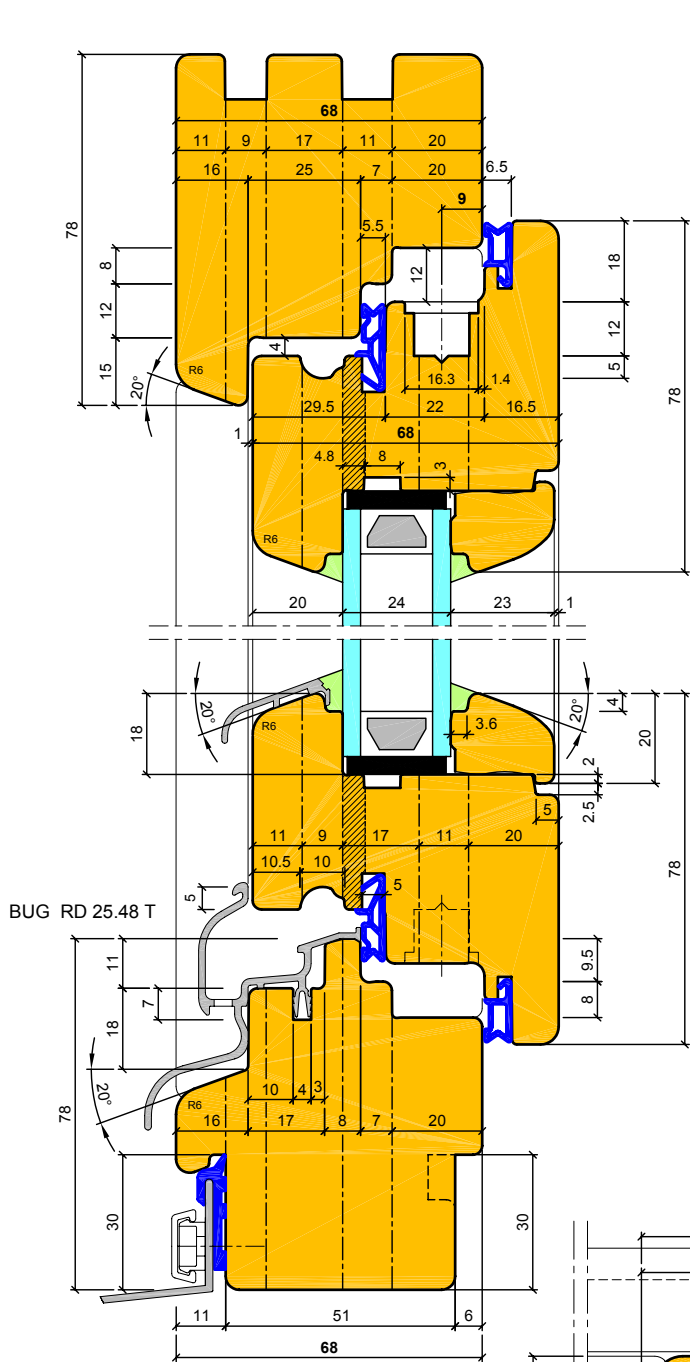

IV 68 Vertikalschnitt

Regenschiene 25mm

1 Falzdichtung

1 Überschlafdichtung

Gleiche Schlitz - Zapfenteilung
bei Flügel und Stock (2-fach)

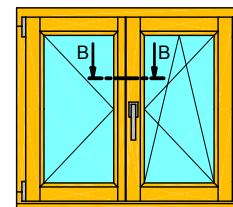

**Mittelschluß (Stulp)
mit Schlagleiste**

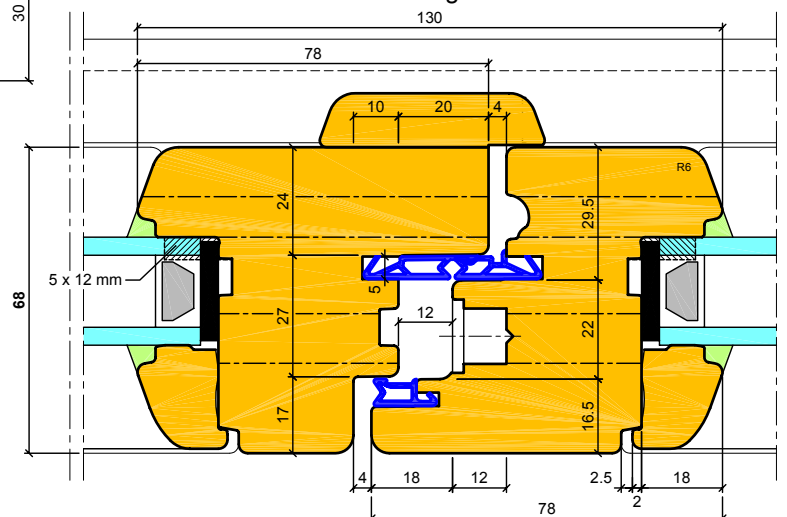

Flügel innen

KW.54970.4 A1

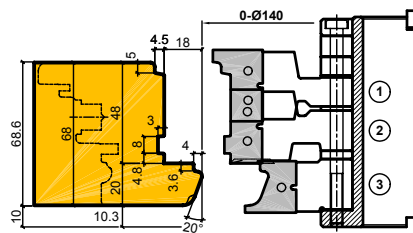

Flügel außen Gegenlauf

KW.54975.4 B1

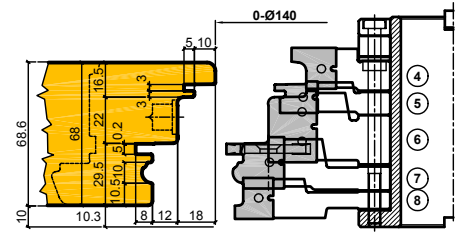

Flügel Schlitz

KW.54972.4 C1

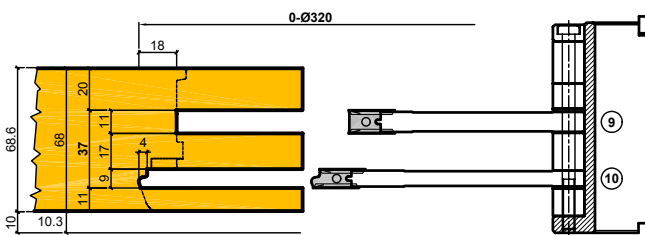

Flügel Zapfen

KW.54973.4 D1

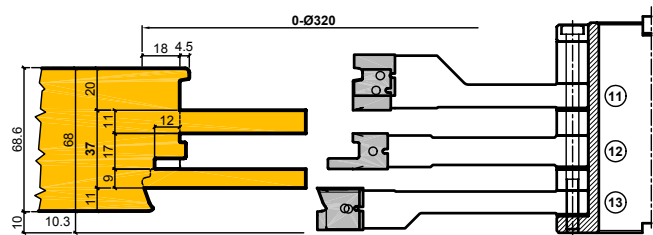

Getriebenut

KW.54976.4 E1

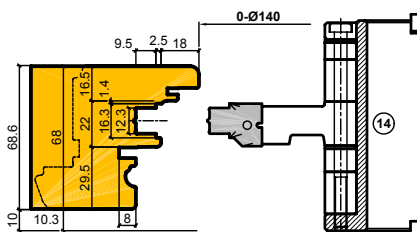

Flügel außen Mittelschluß (Stulp)

KW.56868.4 F1

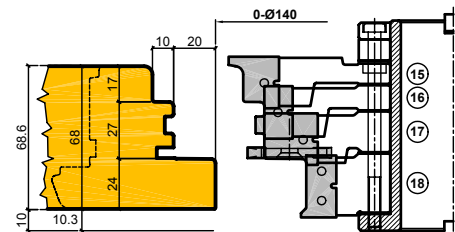

Stock innen aufrecht und oben

KW.54980.4 G1

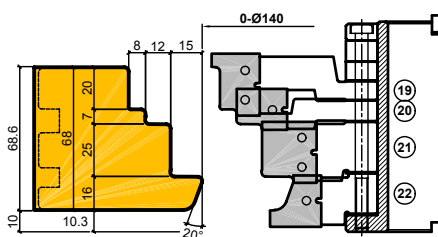

Stock innen unten

KW.54981.4 H1

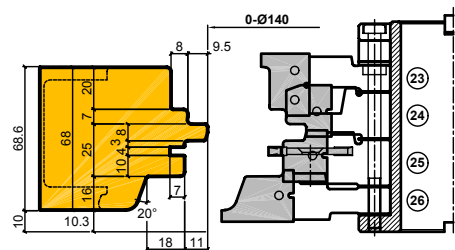

Stock außen unten

KW.54983.4 I1

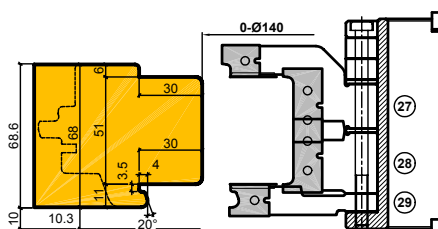

Stock Schlitz

KW.54979.4 J1

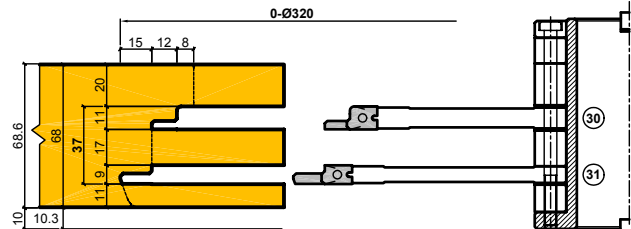

Stock Zapfen aufrecht oben

KW.54977.4 K1

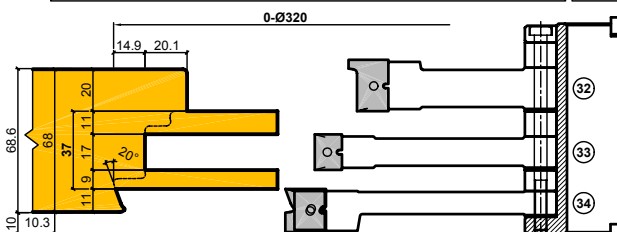

Stock Zapfen aufrecht unten

KW.54978.4 L1

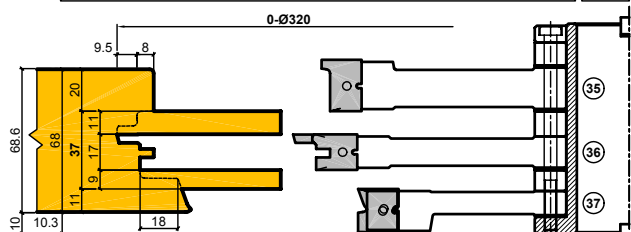

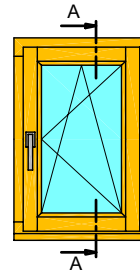
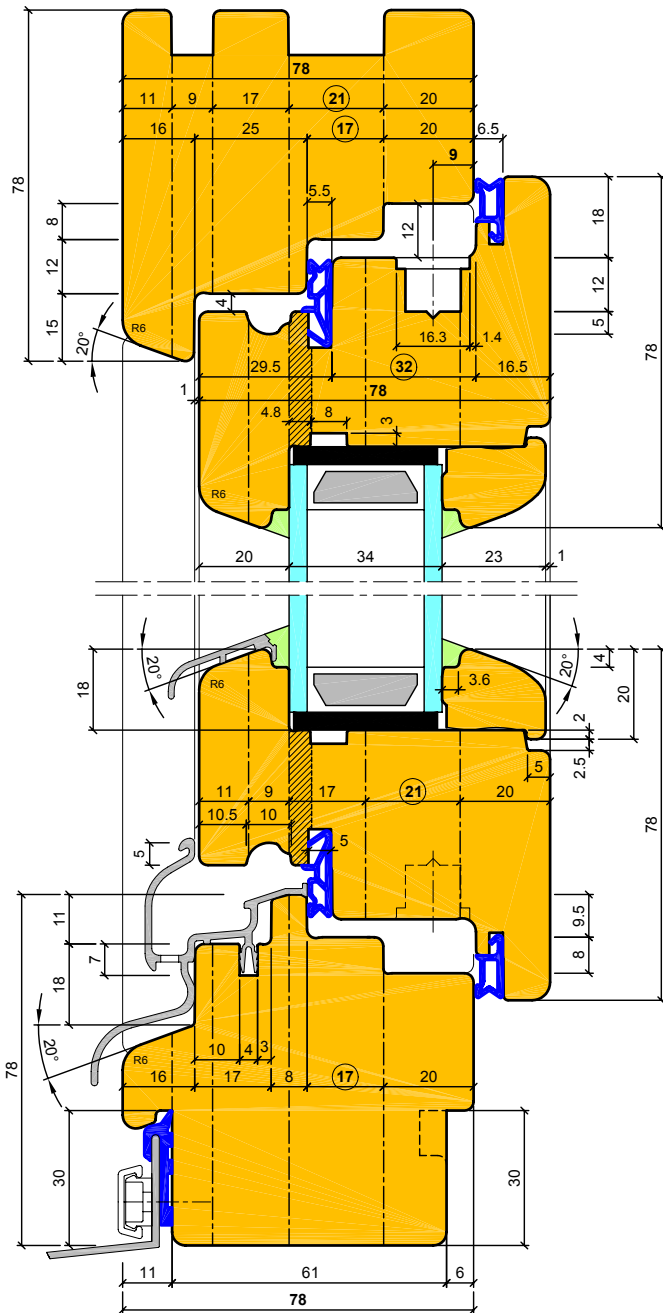

IV 78 Vertikalschnitt
 Regensiene 25mm
 1 Falzdichtung
 1 Überschlafdichtung
 Gleiche Schlitz - Zapfenteilung
 bei Flügel und Stock (2-fach)

Umstellung von IV 68 auf IV 78:

- bei Flügel Schlitz Wechselfräser (38) anstatt Fräser (9) verwenden
- bei Stock Schlitz Wechselfräser (39) anstatt Fräser (30) verwenden
- bei den restlichen Sätzen Fixring 10mm lt. jeweiliger Zeichnung umlegen

Flügel Schlitz KW.57031.4 C2

Stock Schlitz KW.57095.4 J2

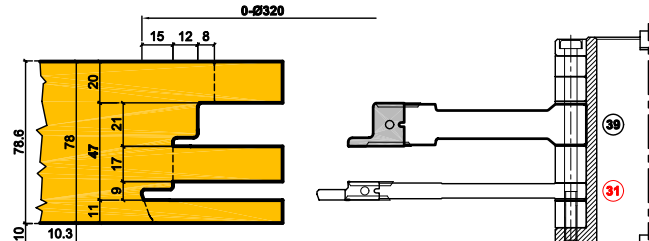
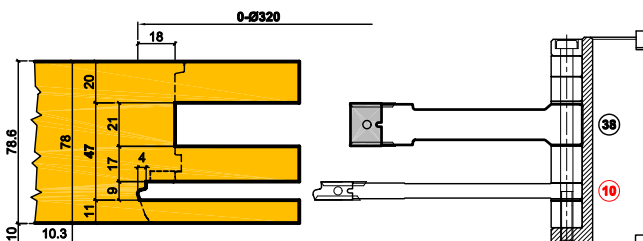

**Variante:
Glaswange mit Rustikal-Profil**

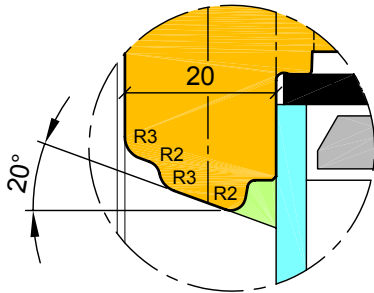

Zur Umstellung der Basis-
Werkzeuge auf Glaswange
bzw. Überschlag mit Profil
ist nur der Austausch der
jeweiligen Profilmesser
notwendig !

**Variante:
Überschlag mit Rustikal-Profil**

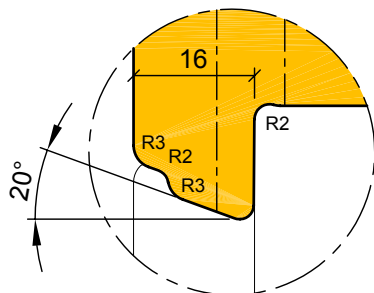

Flügel innen **KW.54970.4** **A3**

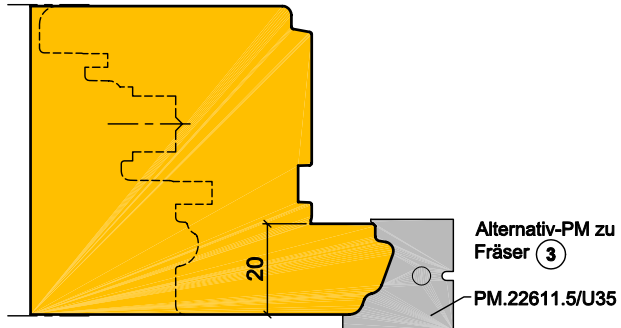

Flügel Zapfen **KW.54973.4** **D3**

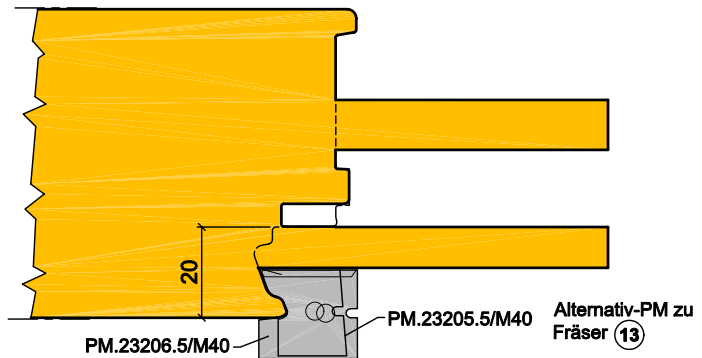

Stock innen aufrecht und oben **KW.54980.4** **G3**

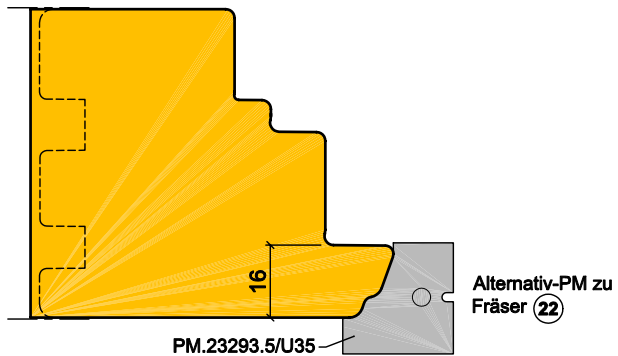

Stock Zapfen aufrecht oben **KW.54977.4** **K3**

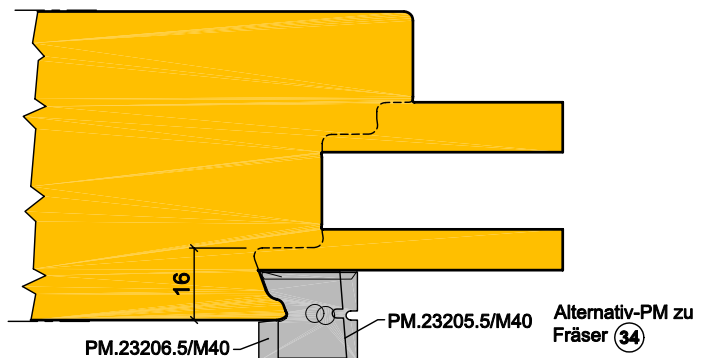

Flügel innen Gegenprofil **KW.54971.4** **M4**

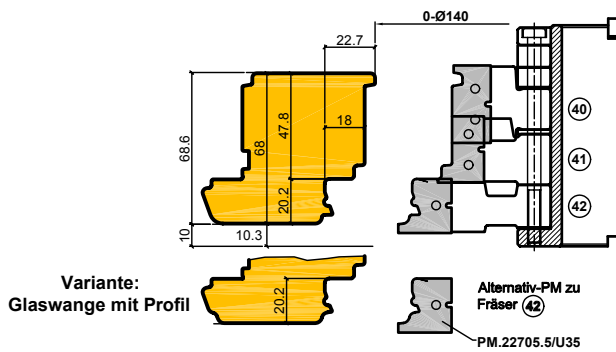

Flügel Konter **KW.54974.4** **N4**

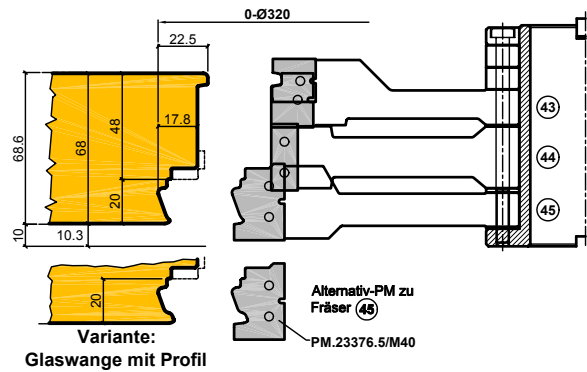

Flügel außen Gleichlauf **KW.55616.4** **O4**

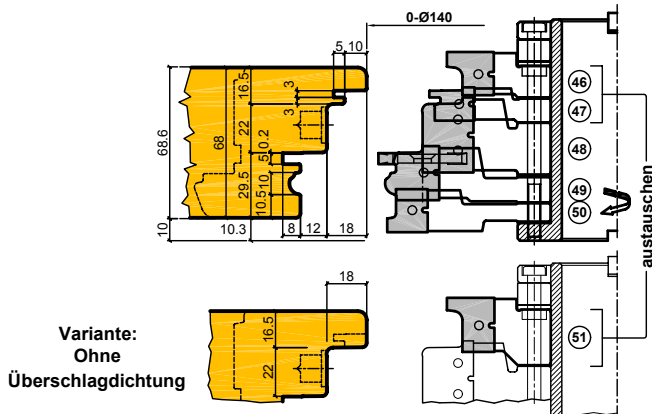

Stock außen aufrecht und oben **KW.54982.4** **P4**

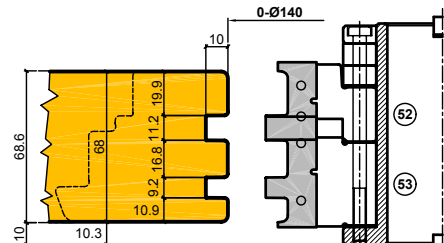

Stock Konter aufrecht unten **KW.54984.4** **Q4**

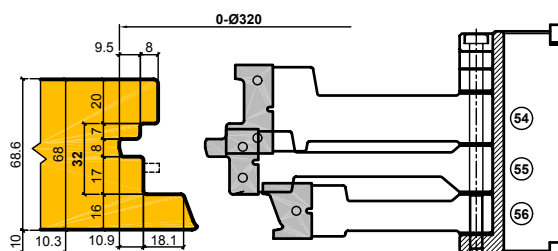

Stock Konter aufrecht oben **KW.54985.4** **R4**

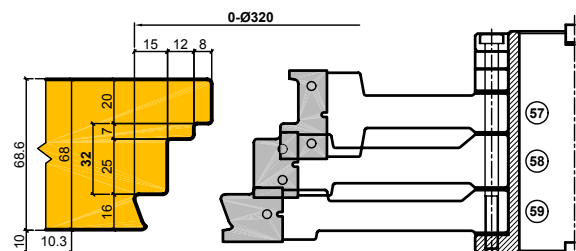

Stock innen unten Gegenprofil **KW.54987.4** **S4**

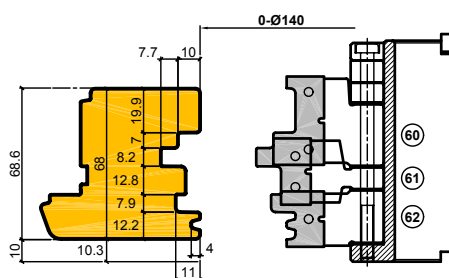

WEINIG UC 6 Fixhub
Spindelanordnung

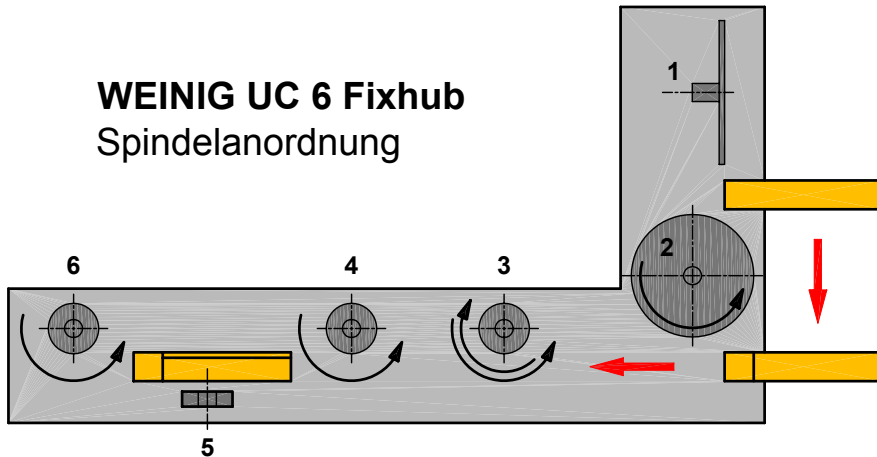

- Beispiel zeigt Fensterherstellung auf Maschine WEINIG UC 6
- bemaßte Fensterschnitte siehe A700 IV 68 Fenstersystem

Austauschsätze für SPINDEL 4
Flügel-Umfräsung

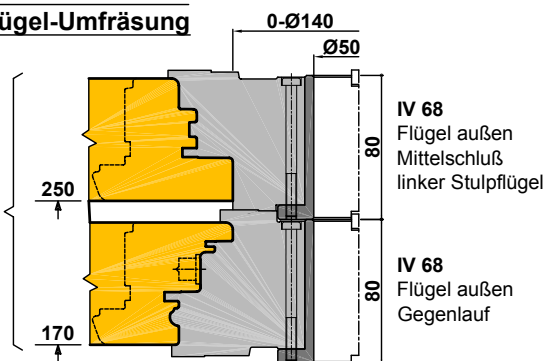

Austausch

SPINDEL 6

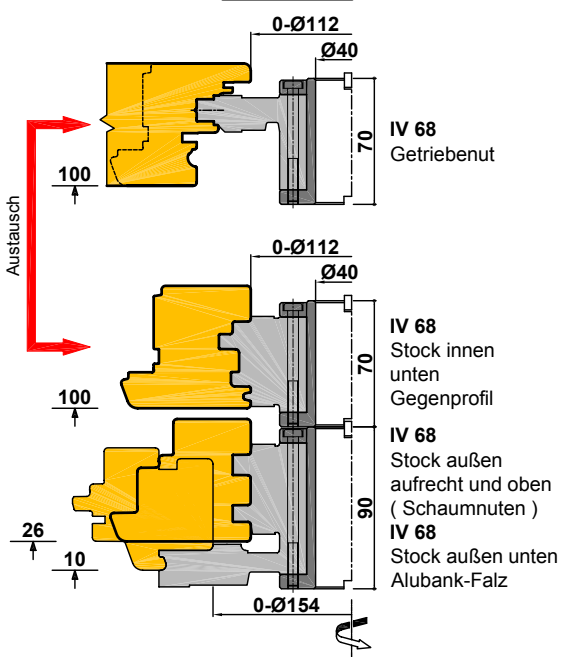

SPINDEL 5

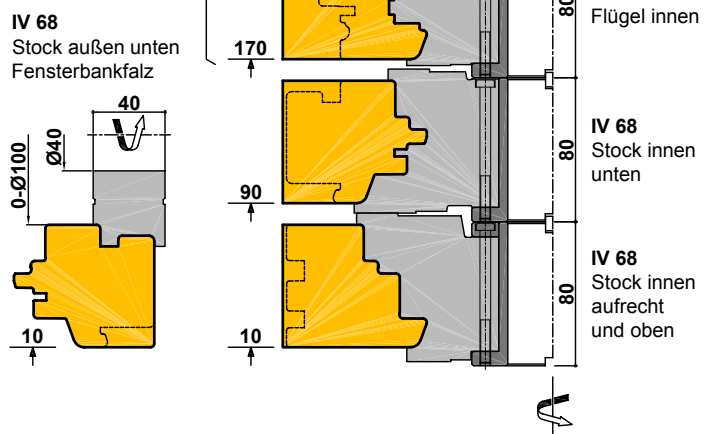

SPINDEL 1

Ablängsäge

SPINDEL 2
Austauschsätze für Flügel

0-Ø320

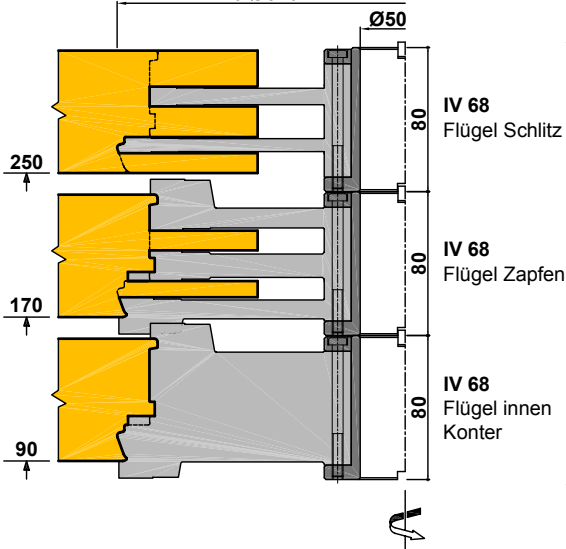

SPINDEL 2
Schlitz- / Zapfenfertigung Stock

0-Ø320

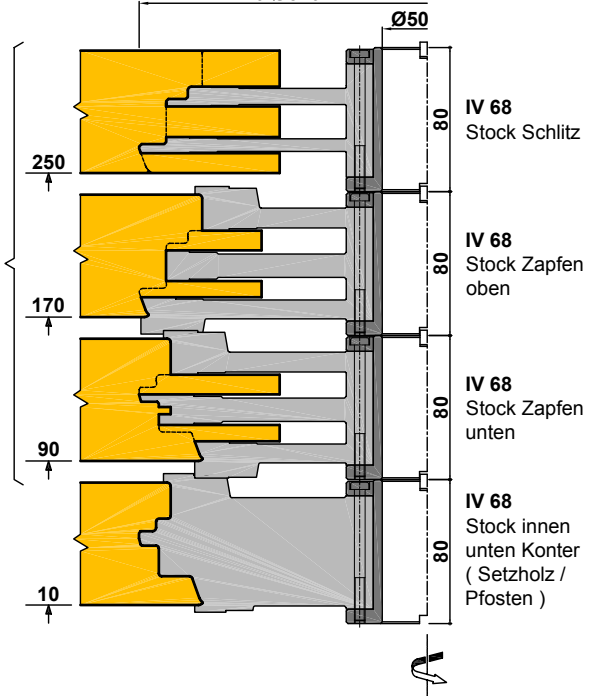

SPINDEL 3

0-Ø140

Austauschsatz für Flügel-Umfräsung

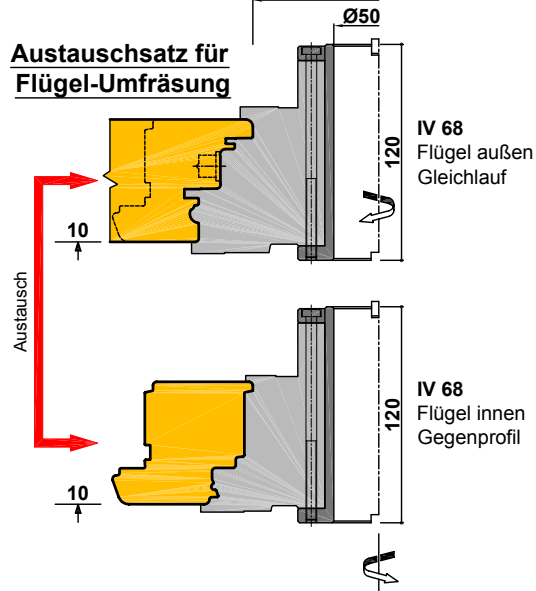

Glasleiste KW.57461.4 Ta6

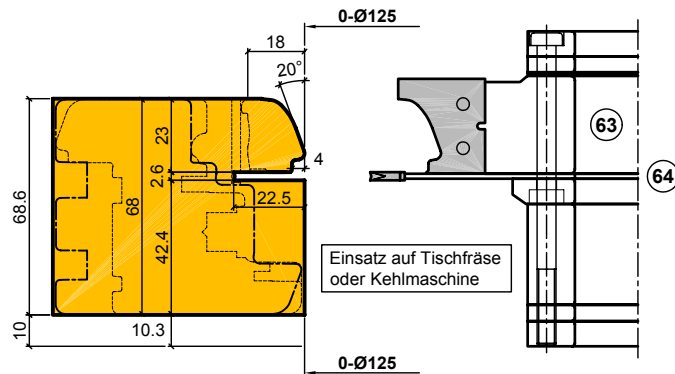

Glasleiste trennen KW.57329.4 Ua6

Glasleiste überfäzt
M 1:1

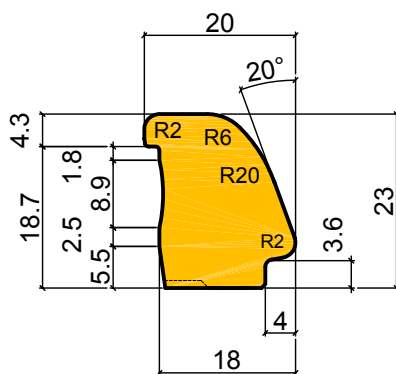

Glasleiste aus:
 --- Flügel außen
 Stock innen aufrecht und oben

Einsatz auf Kehlmaschine

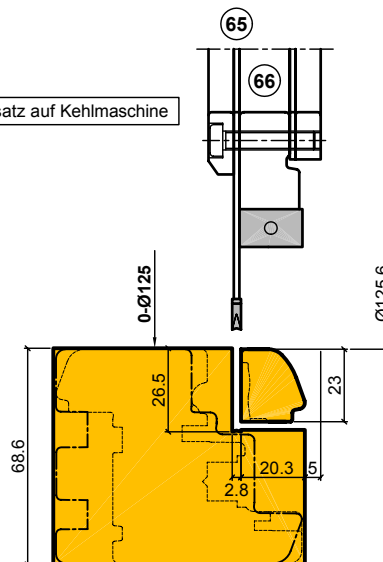

Glasleiste trennen KW.57330.4 Va6

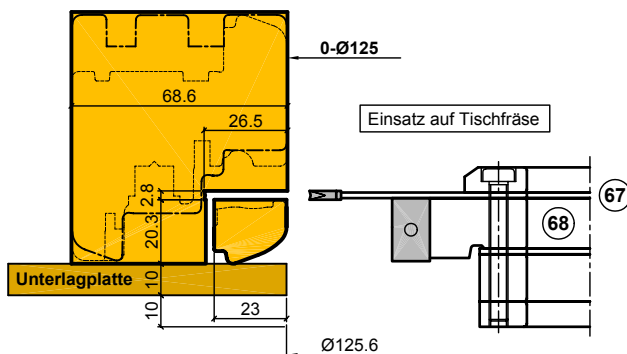

Glasleiste / Falz fräsen KW.57331.4 Wa6

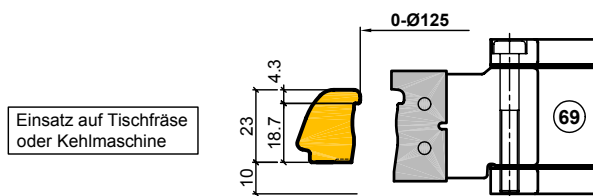

Glasleiste KW.57462.4 Tb6

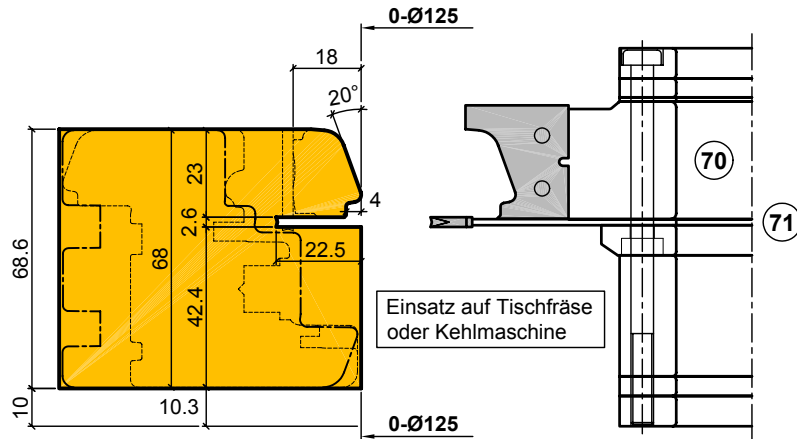

Glasleiste trennen KW.57311.4 Ub6

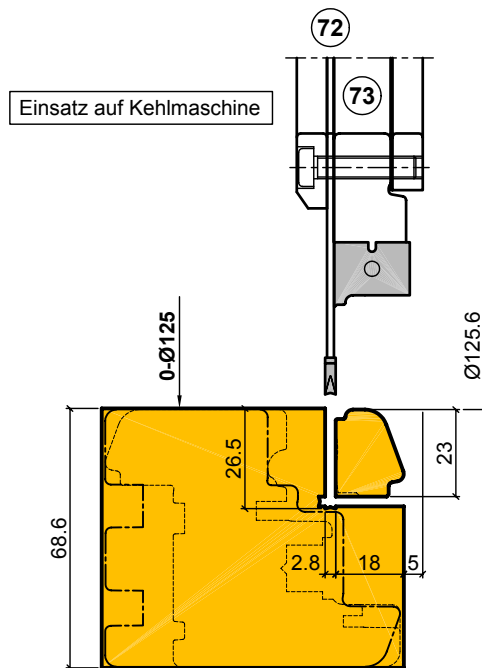
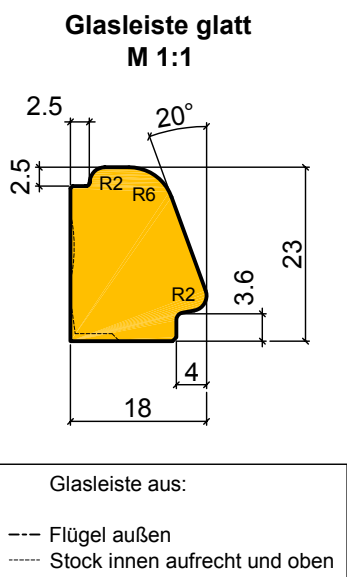

Glasleiste trennen KW.57318.4 Vb6

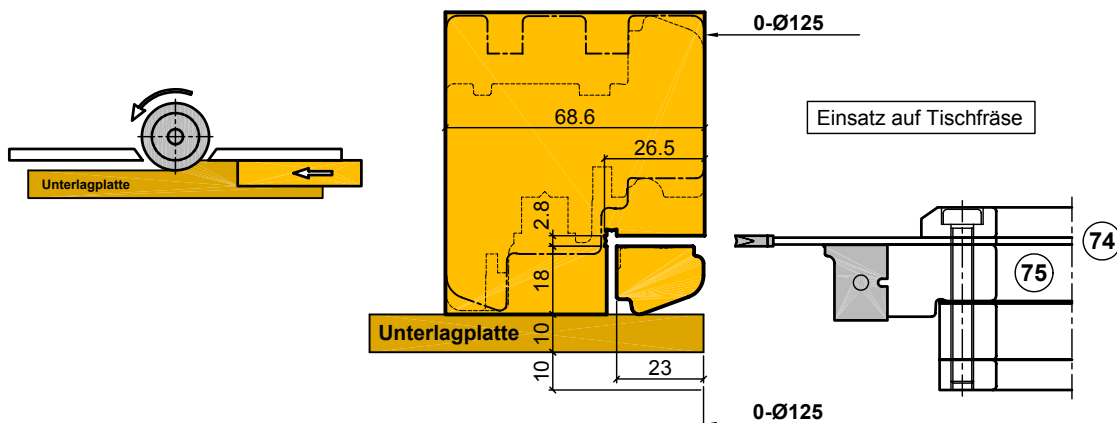

Nr. A706 Rohleiste austrennen

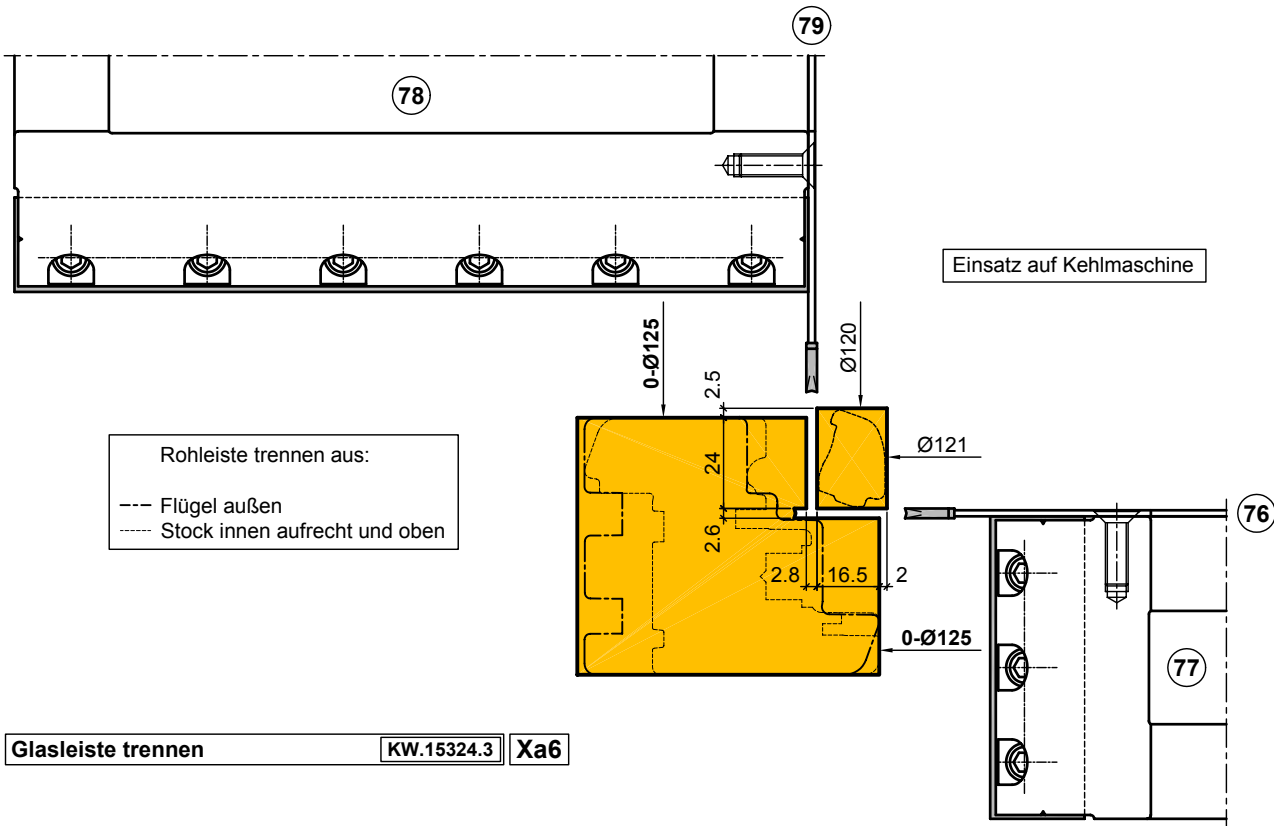

Glasleiste trennen KW.15324.3 Xa6

Nr. A706 Glasleiste profilieren

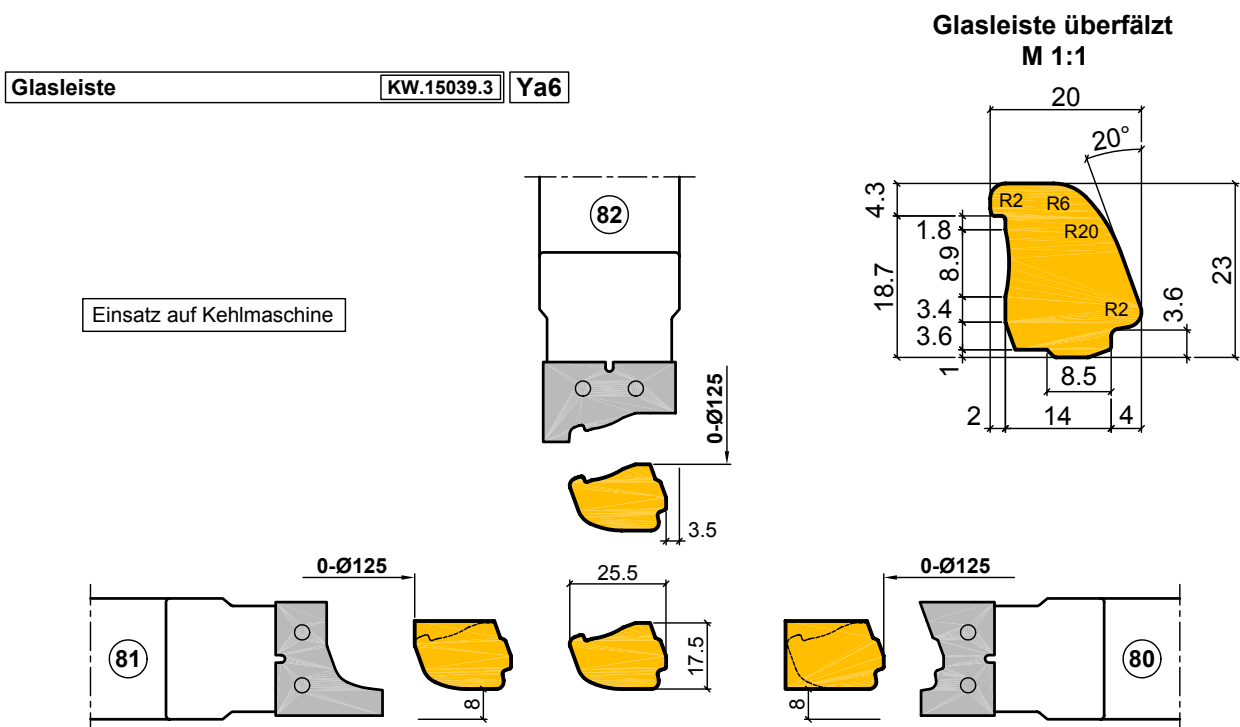

Nr. A706 Rohleiste austrennen

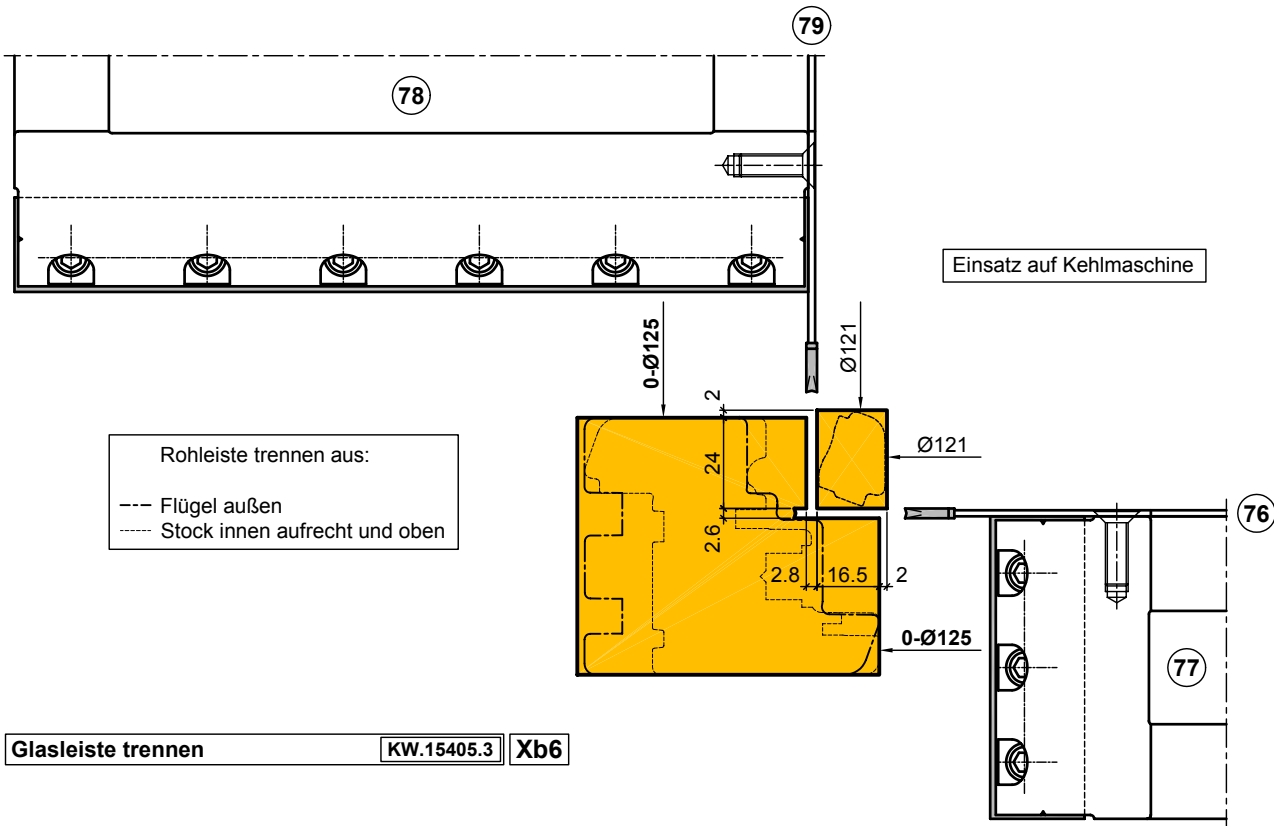

Glasleiste trennen KW.15405.3 Xb6

Nr. A706 Glasleiste profilieren

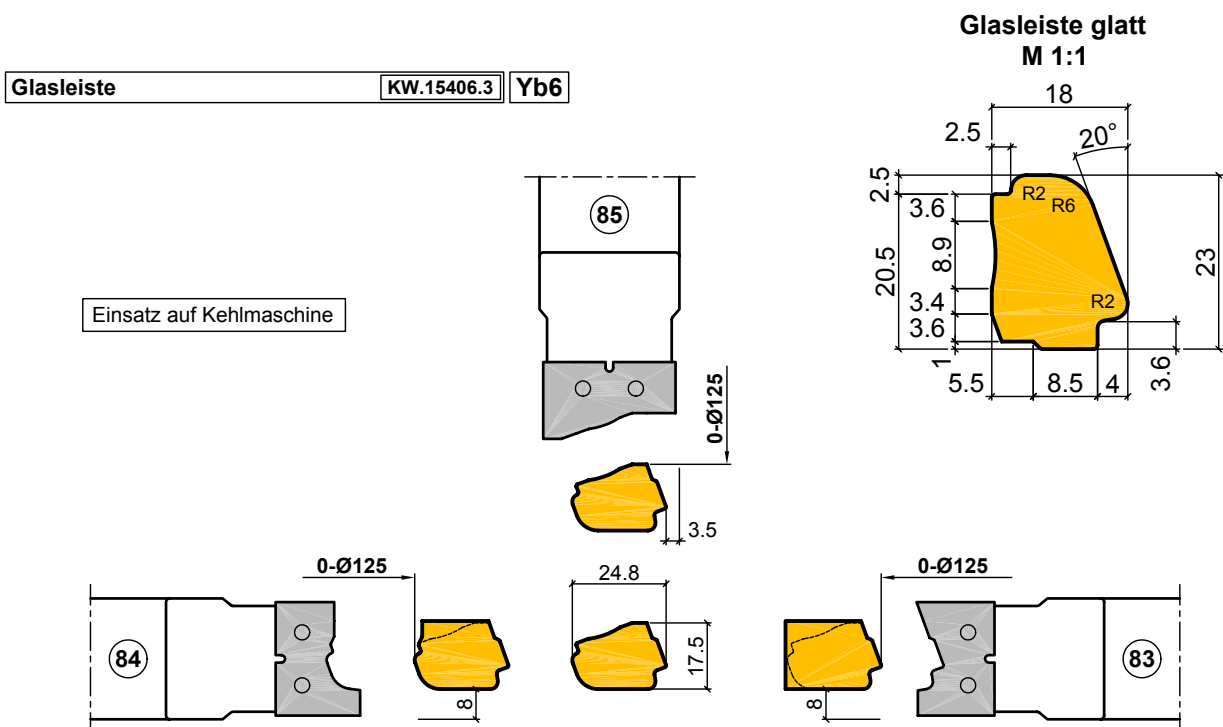

Glasleiste KW.15406.3 Yb6

Flügel innen

KW.57065.4

A7

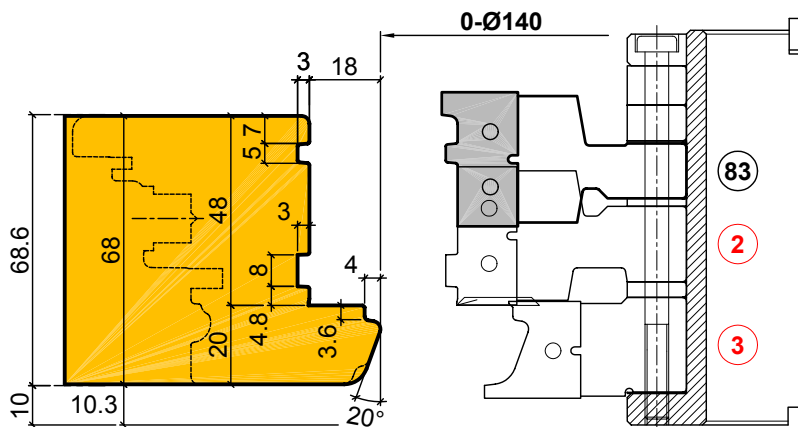

Flügel Zapfen

KW.57069.4

D7

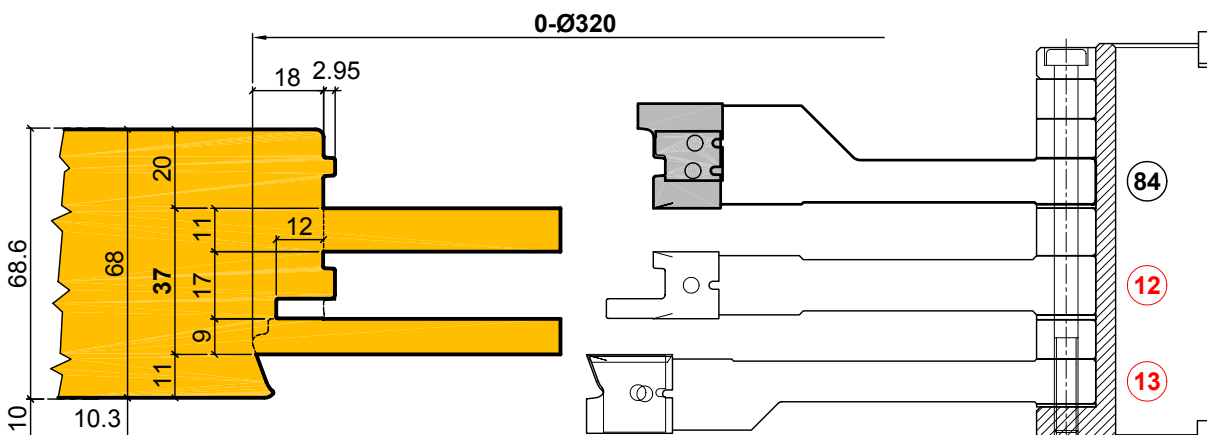

Flügel innen Gegenprofil

KW.57083.4

M7

